

Ausgeführte Objekte

Wärmegeämmte Fassadensysteme

Objets réalisés

Systèmes de façades à rupture de pont thermique

Completed projects

Thermally insulated façade systems



3 Wissenschafts-
zentrum Kopernikus,
Warschau/PL



4 Schloss Novy Svetlov,
Bojkovice/CZ



5 Hotel Magyar Király,
Székesfehérvár/HU



6 Theater- und
Konzerthaus Kilden,
Kristiansand/NO



8 Museum für
moderne Kunst,
Zagreb/HR



10 Museum für Kunst
und Kulturgeschichte
Altona,
Hamburg-Altona/DE



11 TransPort
(Flughafen Schiphol),
Amsterdam/NL



12 Büro- und
Geschäftshaus
«Hillsite»,
Schwalbach am
Taunus/DE



14 Zentralarchiv EDF,
Bure/FR



16 Gemeindehaus,
Ruidellots de la
Selva/ES



17 Hauptbahnhof,
Köln/DE



18 Universität
Lausanne
«Géopolis»,
Lausanne/CH



20 Jansen AG, Campus,
Oberriet/CH



22 Bildungsforum,
Potsdam/DE



24 Besucherzentrum
«Alte Wasserzentrale»,
Pietra Neamt/RO



26 Hotel Novi Spa,
Novi Vinodolski/HR



27 Solvias AG, Büro-
und Lagergebäude,
Kaiseraugst/CH



28 Médiathèque,
Pau/FR



30 «Mumuth» Haus
für Musik &
Musiktheater der
Kunstuniversität,
Graz/AT



32 Centre Pompidou,
Metz/FR



33 Alters- und
Pflegeheim,
Burgdorf/CH



34 Drents Museum,
Assen/NL



36 Akustik-Tunnels,
Warschau/PL



38 Jin Ji Hu
Kempinski Hotel,
Suzhou/CN

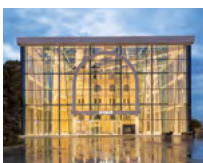

39 Historisches
Museum,
Kharkov/UA



40 Kunstgebäude,
Stuttgart/DE



42 3-Feldsporthalle,
Ingelfingen/DE



44 Musikkonservatorium,
Bilbao/ES



45 Landesberufsschule,
Mureck/AT



46 Hafencity Schule,
Hamburg/DE



48 Drehrestaurant
«Hoher Kasten»,
Brülisau/CH



50 Hauptbahnhof
«Rotterdam Centraal»,
Rotterdam/NL



52 IGuzzini
Illuminazione,
Barcelona/ES



54 «Erasmus»
Studenten-Pavillon,
Rotterdam/NL



56 Hochschule
«Anstalt für
angewandte
Wissenschaften»,
Dessau/DE



57 Justizgebäude,
Würzburg/DE



58 Halle M, Jansen AG,
Oberriet/CH



60 Vogtlandhalle
(Stadthalle),
Greiz/DE



62 Ausbau Messehalle
BEA Expo,
Bern/CH



63 MAN Nutzfahrzeuge,
Werkserweiterung,
München/DE



64 Museumsquartier,
Den Bosch/NL



66 Werkhalle
Glas Trösch,
St.Gallen/CH



67 Voentorg Center,
Moskau/R



68 Neue Messehalle
(Kielce Trade Fairs),
Kielce/PL

Ausgeführte Objekte Objets réalisés Completed projects

JANSEN

Objekt:

Wissenschaftszentrum Kopernikus,
Centrum Nauki Kopernik, Warschau/PL

System:

VISS TVS, VISS SG, VISS Fire,
Janisol 2 EI30, Janisol SG

Architekt:

RAR-2 Laboratorium Architektury
Jan Kubec, Ruda Śląska/PL

Objet:

Centre de recherche Copernique,
Centrum Nauki Kopernik, Varsovie/PL

Système:

VISS TVS, VISS SG, VISS Fire,
Janisol 2 EI30, Janisol SG

Architecte:

RAR-2 Laboratorium Architektury
Jan Kubec, Ruda Śląska/PL

Project:

Copernicus Science Centre,
Centrum Nauki Kopernik, Warsaw/PL

System:

VISS TVS, VISS SG, VISS Fire,
Janisol 2 EI30, Janisol SG

Architect:

RAR-2 Laboratorium Architektury
Jan Kubec, Ruda Śląska/PL



Ausgeführte Objekte
Objets réalisés
Completed projects



Objekt:

Schloss Novy Svetlov, Bojkovice/CZ

System:

VISS SG, VISS TVS (schräg)

Architekt:

Stavos s.r.o., Příbram/CZ

Objet:

Château Novy Svetlov, Bojkovice/CZ

Système:

VISS SG, VISS TVS (oblique)

Architecte:

Stavos s.r.o., Příbram/CZ

Project:

Novy Svetlov castle, Bojkovice/CZ

System:

VISS SG, VISS TVS (sloping)

Architect:

Stavos s.r.o., Příbram/CZ

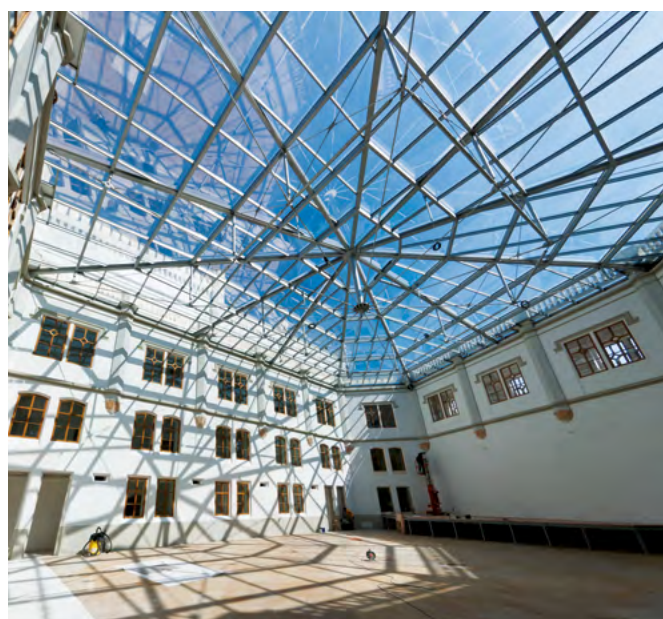

Objekt:

Hotel Magyar Király,
Székesfehérvár/HU

System:

VISS TVS (schräg)

Architekt:

Szendro Epitesz Studio, Budapest/HU

Objet:

Hôtel Magyar Király,
Székesfehérvár/HU

Système:

VISS TVS (oblique)

Architecte:

Szendro Epitesz Studio, Budapest/HU

Project:

Hotel Magyar Király, Székesfehérvár/
HU

System:

VISS TVS (sloping)

Architect:

Szendro Epitesz Studio, Budapest/HU

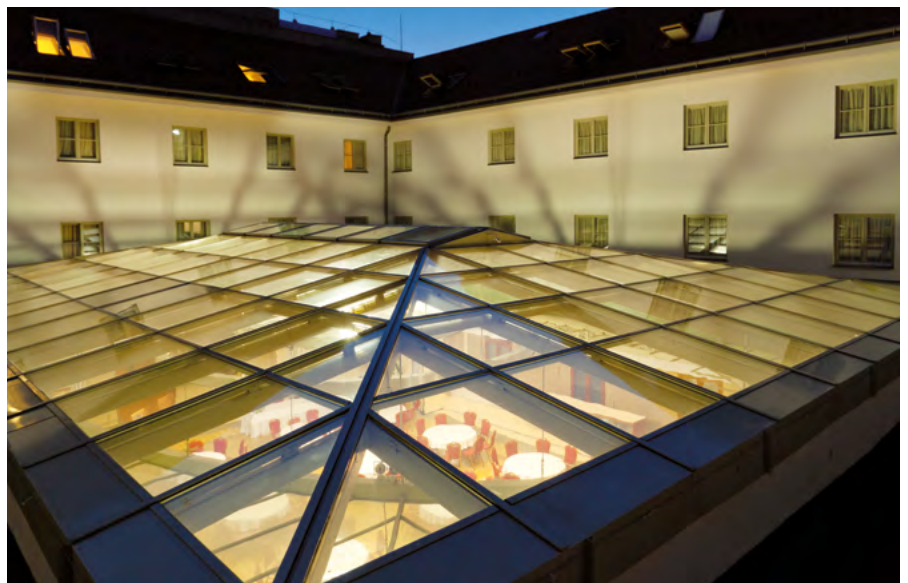

Ausgeführte Objekte

Objets réalisés

Completed projects

Objekt:

Theater- und Konzerthaus Kilden,
Kristiansand/NO

System:

VISS I_xtra

Architekt:

ALA Architects, Helsinki/SF

Objet:

Maison du théâtre et des concerts
Kilden, Kristiansand/NO

Système:

VISS I_xtra

Architecte:

ALA Architects, Helsinki/SF

Project:

Kilden Performing Arts Centre,
Kristiansand/NO

System:

VISS I_xtra

Architect:

ALA Architects, Helsinki/SF



Fotos: Jiri Havran, Oslo

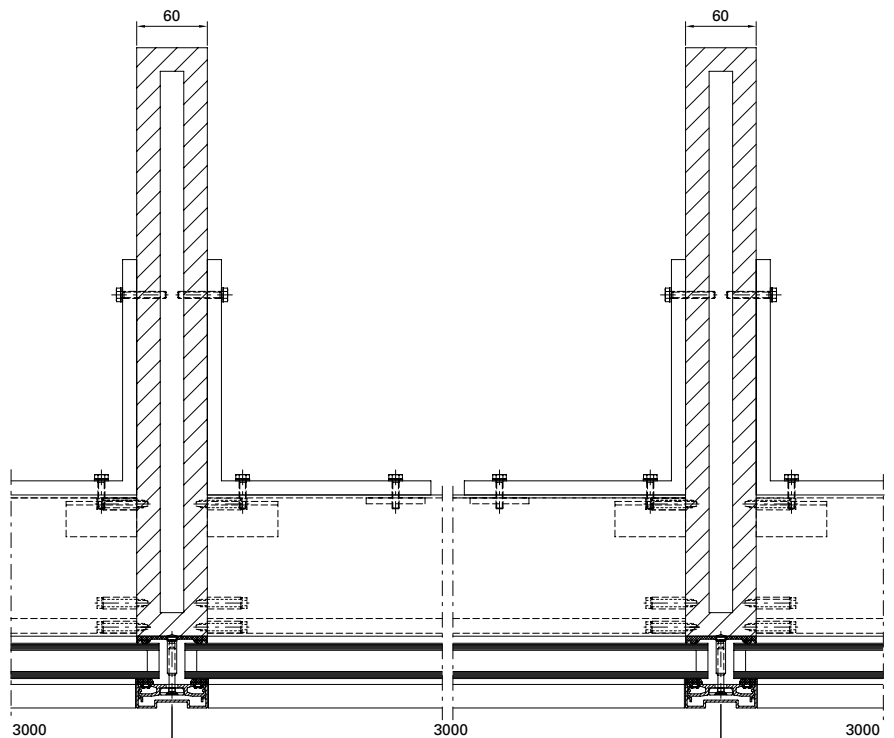
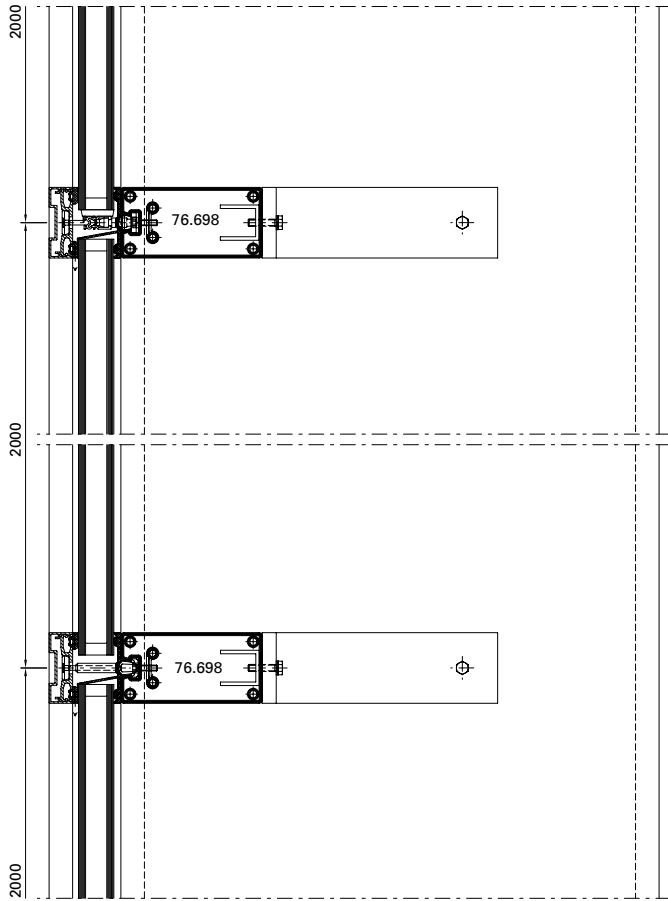

Ausgeführte Objekte

Objets réalisés

Completed projects

Objekt:

Museum für moderne Kunst, Zagreb/
HR

System:

VISS SG

Architekt:

Igor Franić Architekturstudio SZA,
Zagreb/HR

Objet:

Musée de l'art contemporain,
Zagreb/HR

Système:

VISS SG

Architecte:

Igor Franić Architekturstudio SZA,
Zagreb/HR

Project:

Museum of Contemporary Art, Zagreb/
HR

System:

VISS SG

Architect:

Igor Franić Architekturstudio SZA,
Zagreb/HR

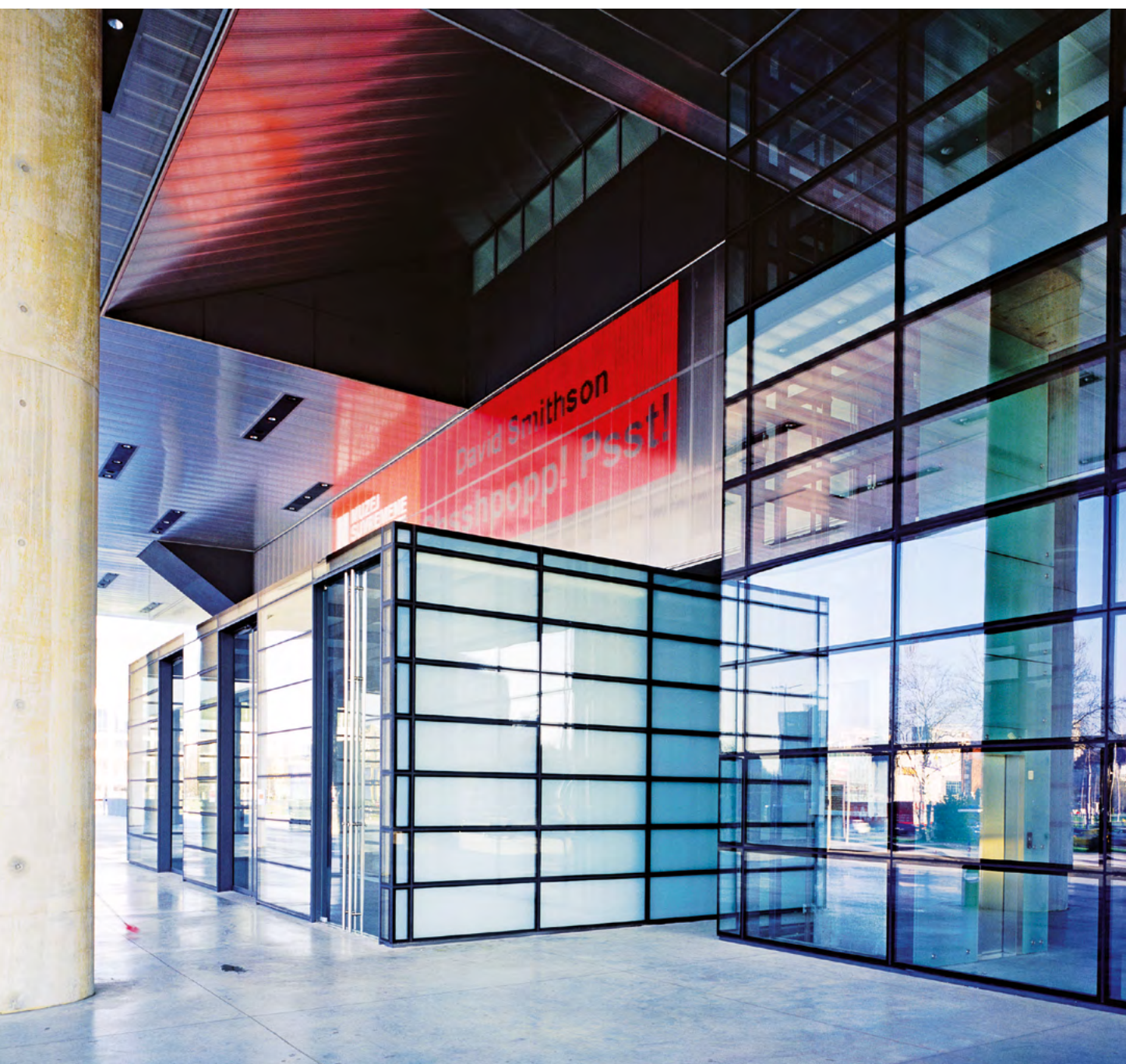



Ausgeführte Objekte
Objets réalisés
Completed projects



Objekt:

Museum für Kunst und
Kulturgeschichte Altona,
Hamburg-Altona/DE

System:

VISS I_xtra, Janisol 2 EI30

Architekt:

Störmer Murphy and Partners GbR,
Hamburg/DE

Objet:

Musée de l'art et de l'histoire
de la civilisation Altona,
Hambourg-Altona/DE

Système:

VISS I_xtra, Janisol 2 EI30

Architecte:

Störmer Murphy and Partners GbR,
Hambourg/DE

Project:

Altona Museum of Art and
Cultural History Altona,
Hamburg-Altona/DE

System:

VISS I_xtra, Janisol 2 EI30

Architect:

Störmer Murphy and Partners GbR,
Hamburg/DE



Fotos: Jochen Helle, Dortmund

Objekt:

TransPort (Flughafen Schiphol),
Amsterdam/NL

System:

VISS Basic TVS Fire, VISS TVS

Architekt:

Architectenbureau Paul de Ruiter,
Amsterdam/NL

Objet:

TransPort (aéroport Schiphol),
Amsterdam/NL

Système:

VISS Basic TVS Fire, VISS TVS

Architecte:

Architectenbureau Paul de Ruiter,
Amsterdam/NL

Project:

TransPort (Schiphol airport),
Amsterdam/NL

System:

VISS Basic TVS Fire, VISS TVS

Architect:

Architectenbureau Paul de Ruiter,
Amsterdam/NL



Fotos. Pieter Kers/NL

Ausgeführte Objekte

Objets réalisés

Completed projects

Objekt:

Büro- und Geschäftshaus «Hillsite»,
Schwalbach am Taunus/DE

System:

VISS Semi SG

Architekt:

Meixner-Schlüter-Wendt Architekten,
Frankfurt am Main/DE

Objet:

Immeuble de bureaux et de commerce
«Hillsite», Schwalbach am Taunus/DE

Système:

VISS Semi SG

Architecte:

Meixner-Schlüter-Wendt Architekten,
Frankfurt am Main/DE

Project:

«Hillsite» office complex,
Schwalbach am Taunus/DE

System:

VISS Semi SG

Architect:

Meixner-Schlüter-Wendt Architekten,
Frankfurt am Main/DE

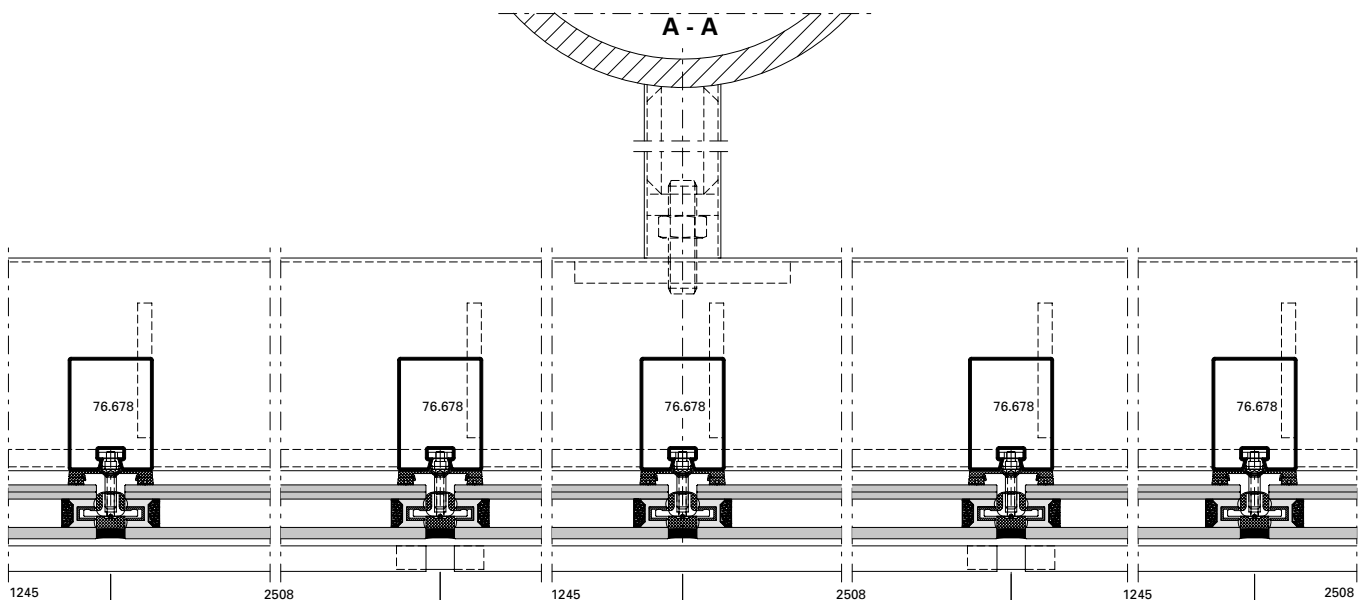

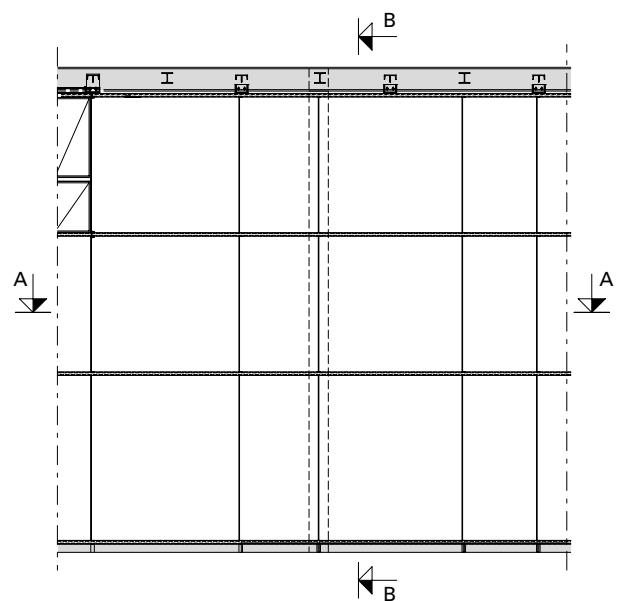
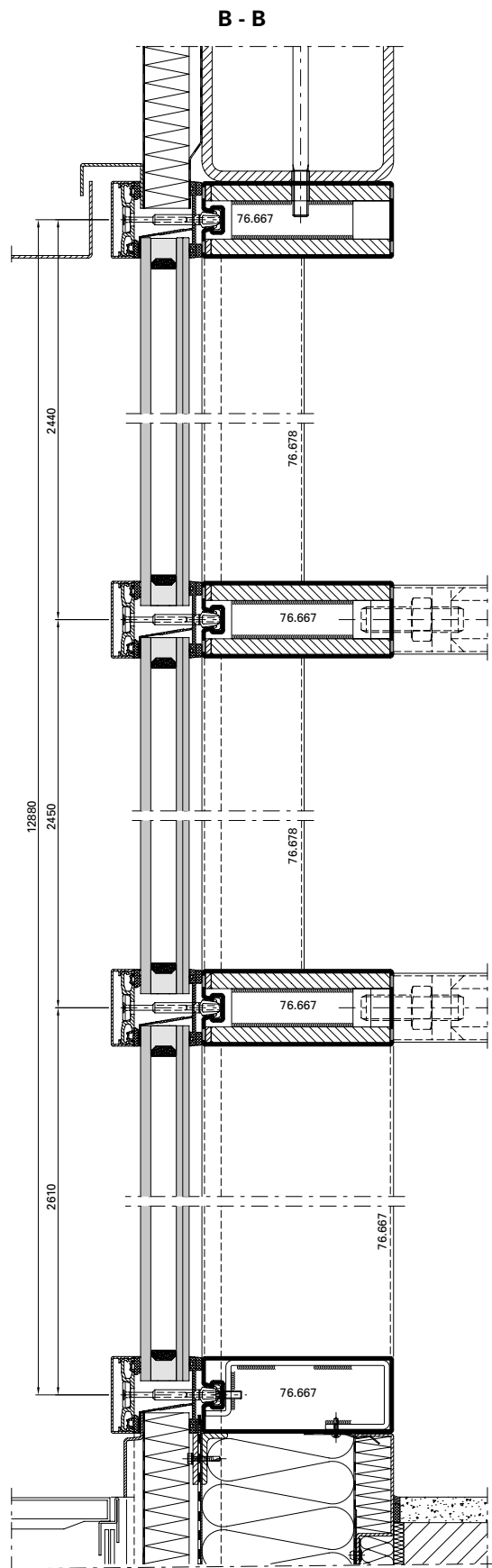

Ausgeführte Objekte Objets réalisés Completed projects

Objekt:

Zentralarchiv EDF, Bure/FR

System:

VISS TVS, Janisol Türen Edelstahl

Architekt:

LAN (Local Architecture Network),
Paris/FR

Objet:

Centre d'archives EDF, Bure/FR

Système:

VISS TVS, portes Janisol acier Inox

Architecte:

LAN (Local Architecture Network), Paris/
FR

Project:

Central archive EDF, Bure/FR

System:

VISS TVS, Janisol doors stainless steel

Architect:

LAN (Local Architecture Network),
Paris/FR

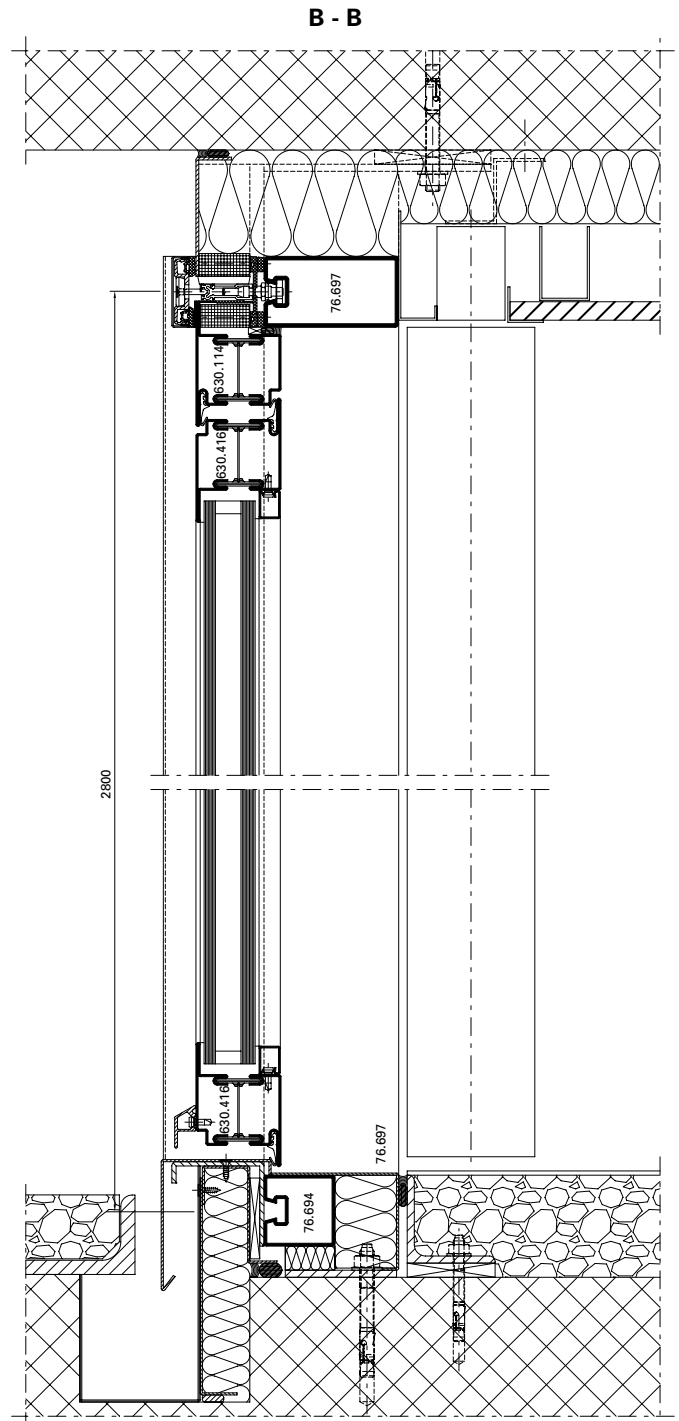
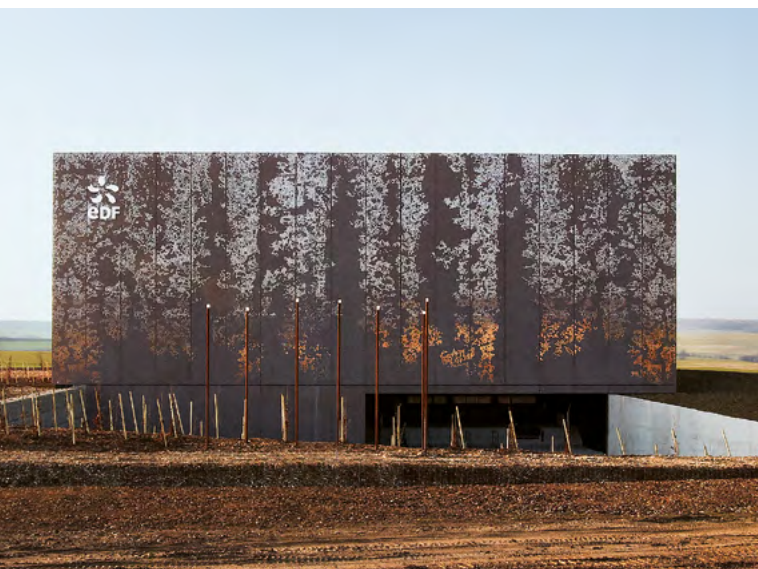

A - A

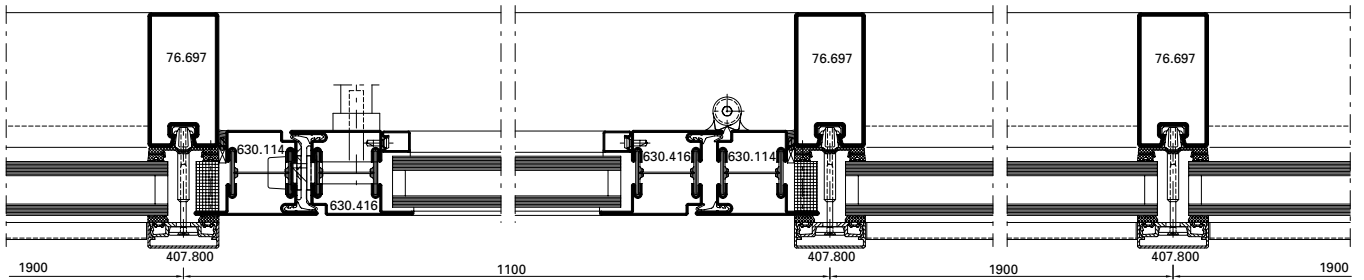

B

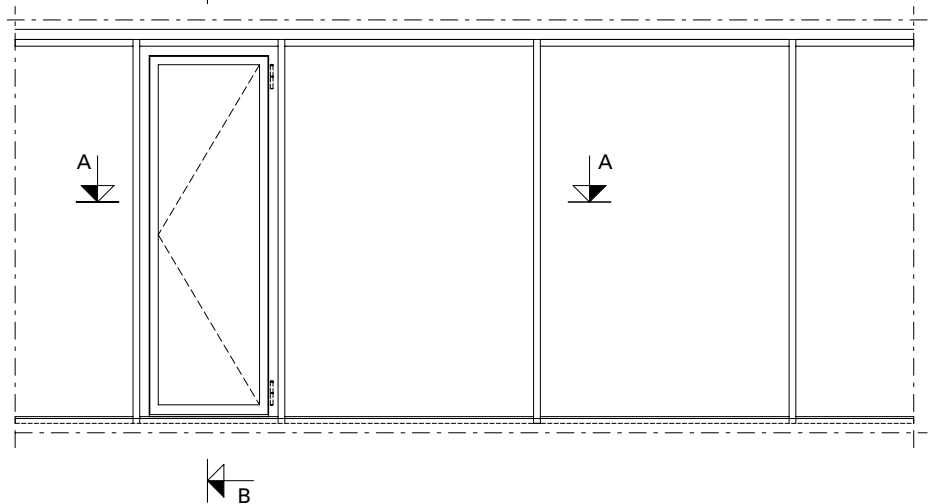

Ausgeführte Objekte

Objets réalisés

Completed projects

Objekt:

Gemeindehaus,
Ruidellots de la Selva/ES

System:

VISS TVS

Architekt:

Pla & Padrosa S.A., Girona/ES

Objet:

Hôtel de ville,
Ruidellots de la Selva/ES

Système:

VISS TVS

Architecte:

Pla & Padrosa S.A., Girona/ES

Project:

Town hall,
Ruidellots de la Selva/ES

System:

VISS TVS

Architect:

Pla & Padrosa S.A., Girona/ES



Objekt:

Hauptbahnhof, Köln/DE

System:

VISS TV, Jansen-Economy 50 Türen,
Janisol Türen Edelstahl

Architekt:

Kopka und Theil Architekten,
Dortmund/DE

Objet:

Gare centrale, Cologne/DE

Système:

VISS TV, portes Jansen-Economy 50,
portes Janisol acier Inox

Architecte:

Kopka und Theil Architekten,
Dortmund/DE

Project:

Central station, Cologne/DE

System:

VISS TV, Jansen-Economy 50 doors,
Janisol stainless steel doors

Architect:

Kopka und Theil Architekten,
Dortmund/DE

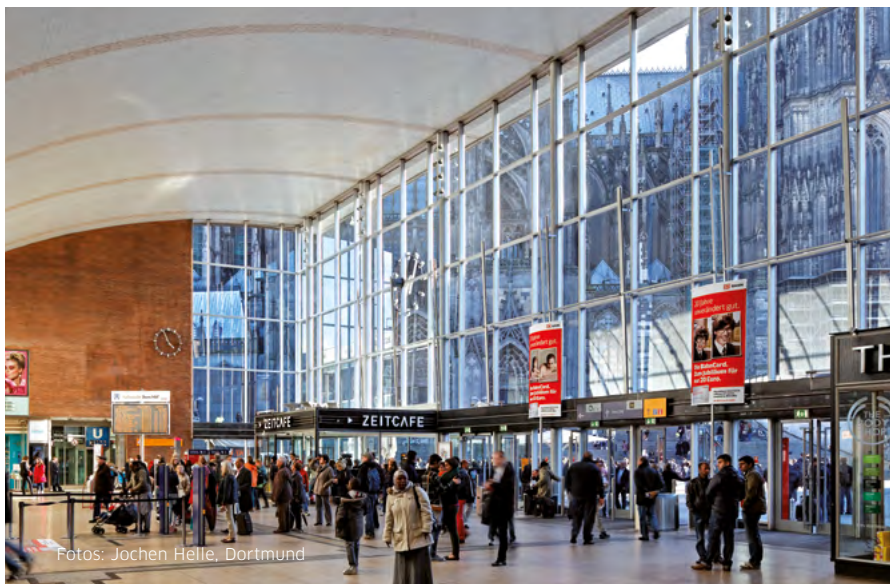

Ausgeführte Objekte Objets réalisés Completed projects

Objekt:

UNIL, Universität Lausanne «Géopolis»,
Lausanne/CH

System:

VISS Fire, VISS TV, Janisol 2 EI30

Architekt:

Itten + Brechbühl Architekten,
Büro Lausanne, Lausanne/CH

Objet:

UNIL, Université de Lausanne
«Géopolis», Lausanne/CH

Système:

VISS Fire, VISS TV, Janisol 2 EI30

Architecte:

Itten + Brechbühl Architekten,
Büro Lausanne, Lausanne/CH

Project:

UNIL, University of Lausanne
«Géopolis», Lausanne/CH

System:

VISS Fire, VISS TV, Janisol 2 EI30

Architect:

Itten + Brechbühl Architekten,
Büro Lausanne, Lausanne/CH

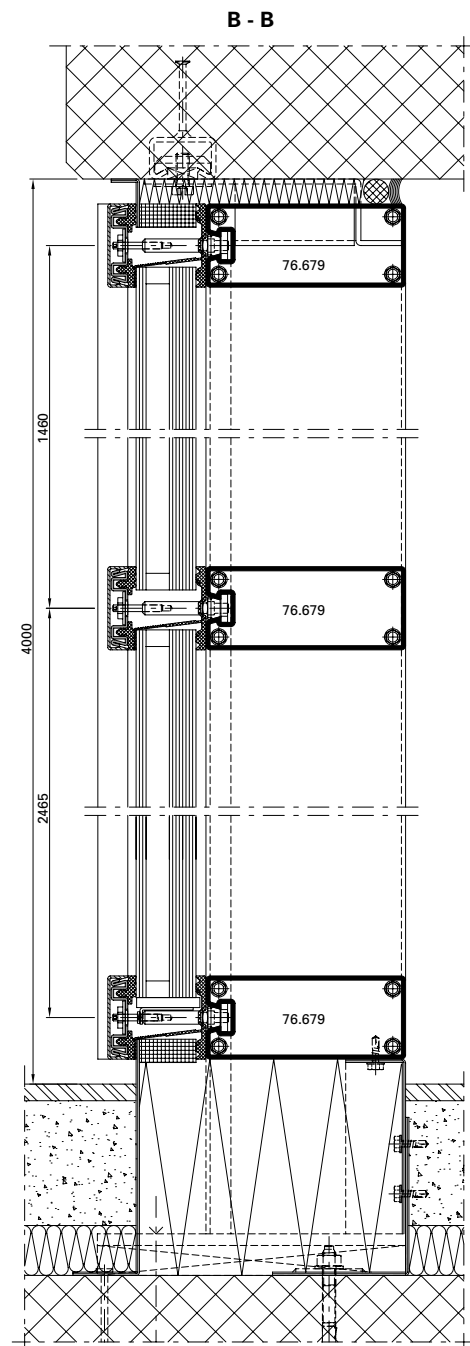

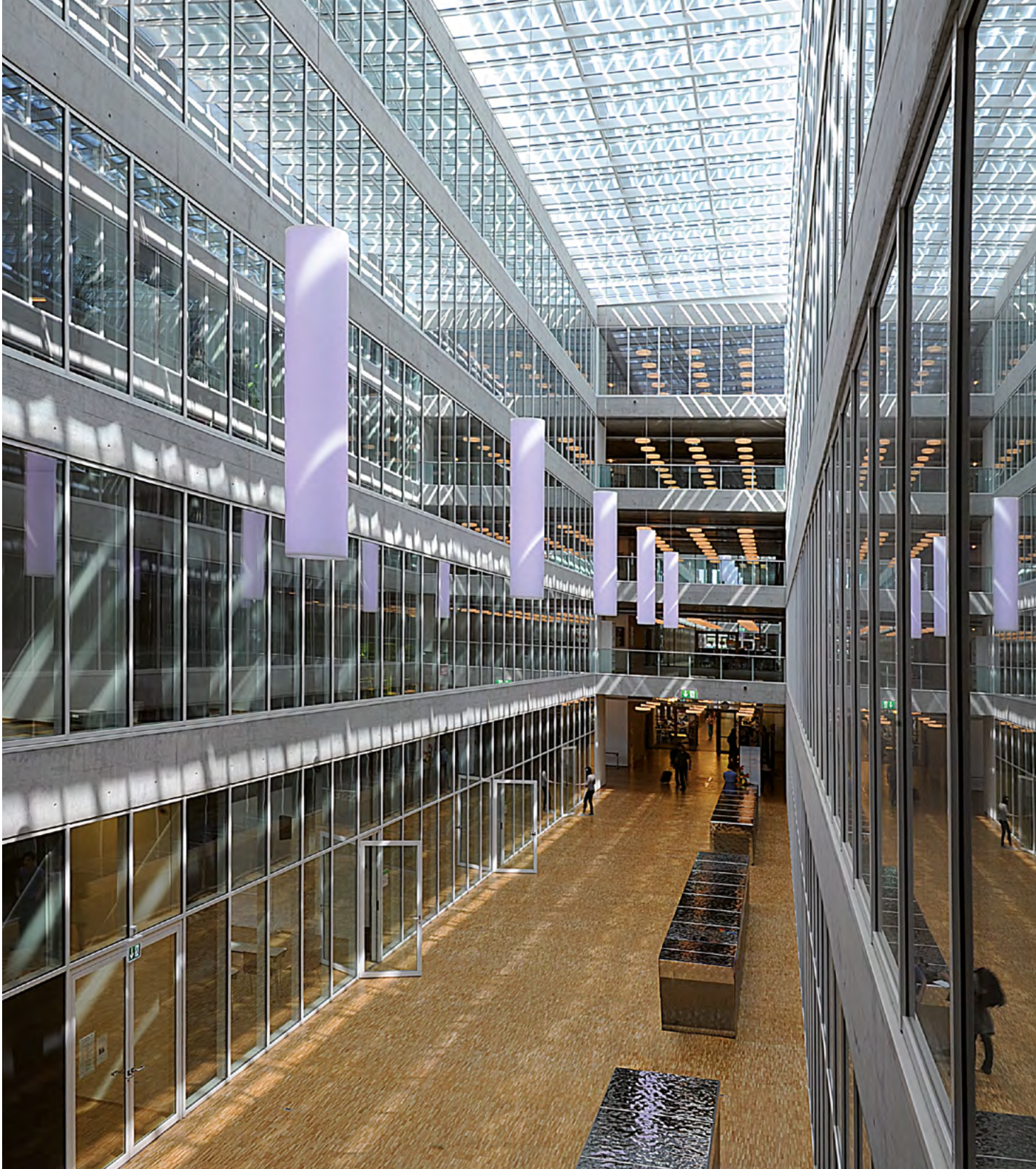

A - A

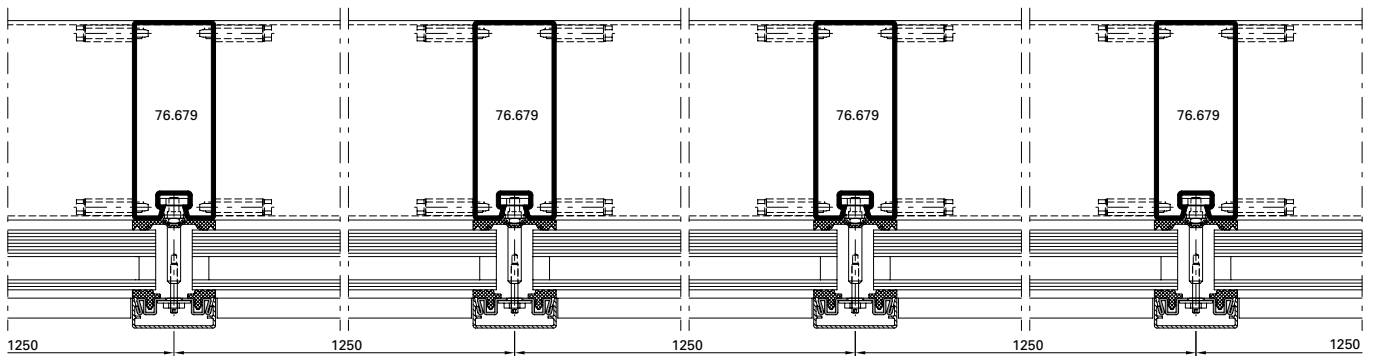

Ausgeführte Objekte

Objets réalisés

Completed projects

Objekt:

Jansen AG, Campus, Oberriet/CH

System:

VISS SG

Architekt:

Davide Macullo Architects, Lugano/CH

Objet:

Jansen AG, Campus, Oberriet/CH

Système:

VISS SG

Architecte:

Davide Macullo Architects, Lugano/CH

Project:

Jansen AG, Campus, Oberriet/CH

System:

VISS SG

Architect:

Davide Macullo Architects, Lugano/CH

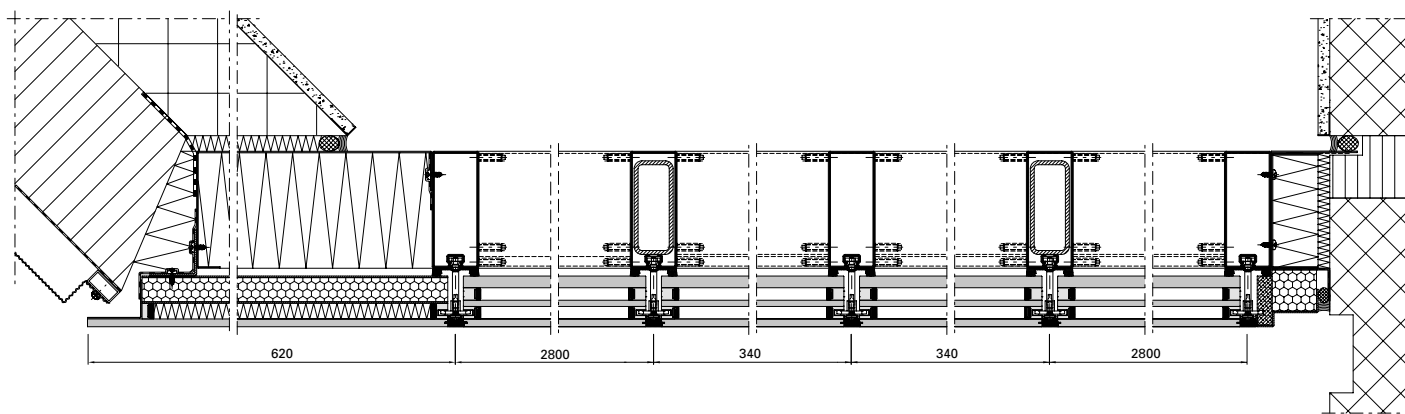

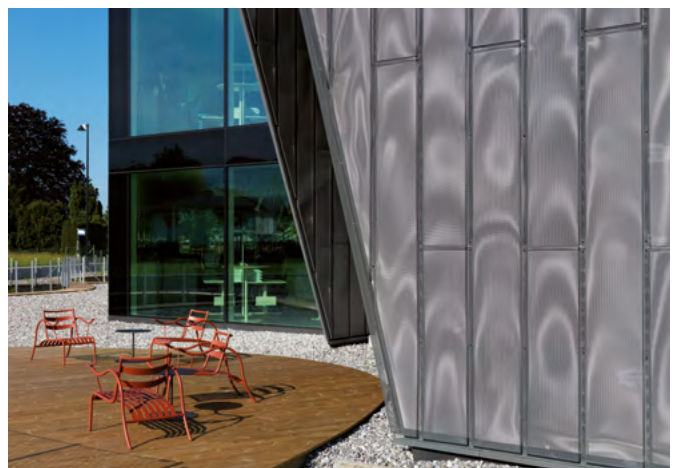
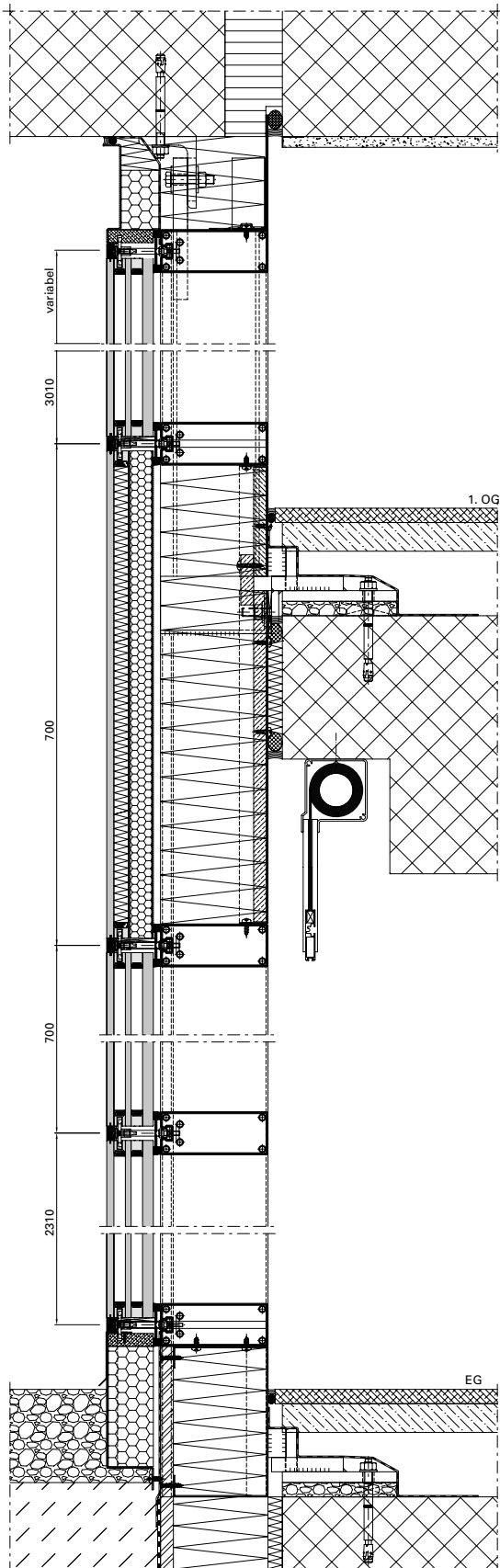

Ausgeführte Objekte

Objets réalisés

Completed projects

Objekt:

Bildungsforum, Potsdam/DE

System:

VISS TVS HI, VISS Fire

Architekt:

Reiner Becker Architekten BDA, Berlin/
DE

Objet:

Forum de formation, Potsdam/DE

Système:

VISS TVS HI, VISS Fire

Architecte:

Reiner Becker Architekten BDA, Berlin/
DE

Project:

Education forum, Potsdam/DE

System:

VISS TVS HI, VISS Fire

Architect:

Reiner Becker Architekten BDA, Berlin/
DE

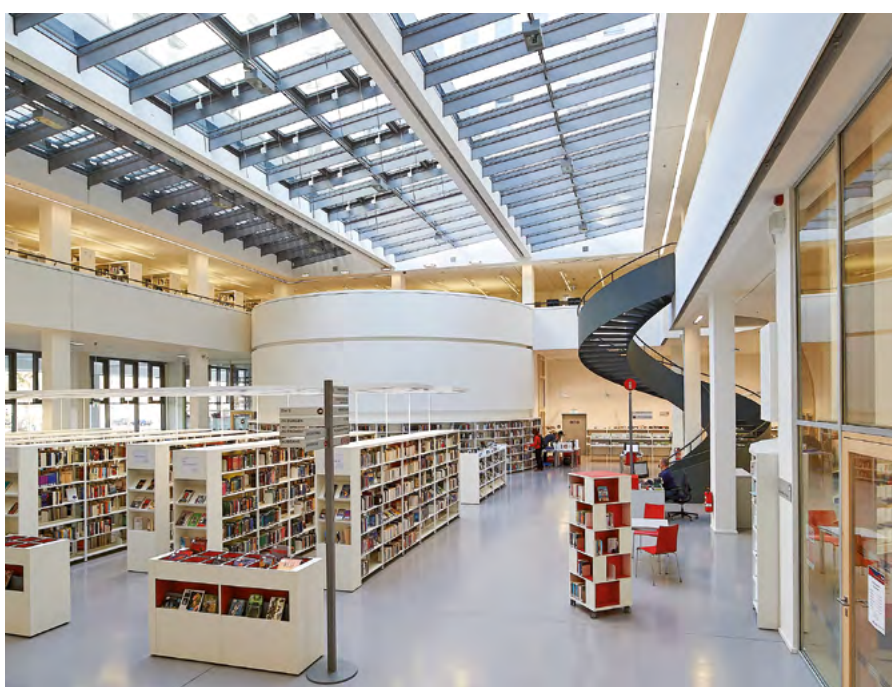



Fotos: Stephan Falk, Berlin



Ausgeführte Objekte

Objets réalisés

Completed projects

Objekt:

Besucherzentrum «Alte Wasserzentrale», Pietra Neamt/RO

System:

VISS TVS

Architekt:

ZIP & BDX Studio, Marius Calin, Bukarest/RO

Objet:

Centre de visiteurs «ancienne centrale des eaux», Pietra Neamt/RO

Système:

VISS TVS

Architecte:

ZIP & BDX Studio, Marius Calin, Bukarest/RO

Project:

Visitor centre «old water station», Pietra Neamt/RO

System:

VISS TVS

Architect:

ZIP & BDX Studio, Marius Calin, Bukarest/RO

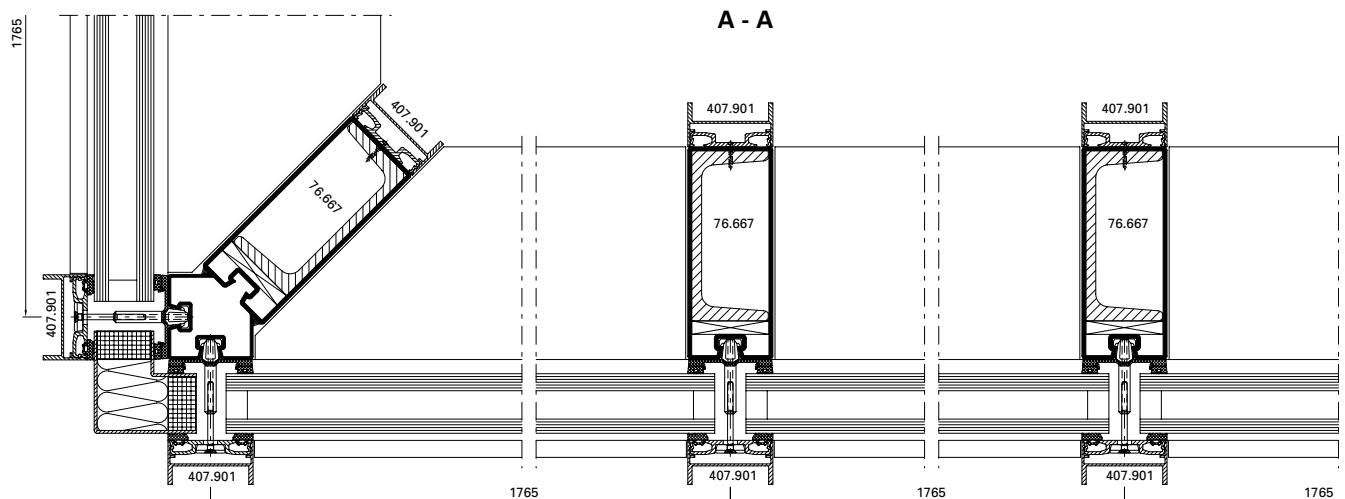
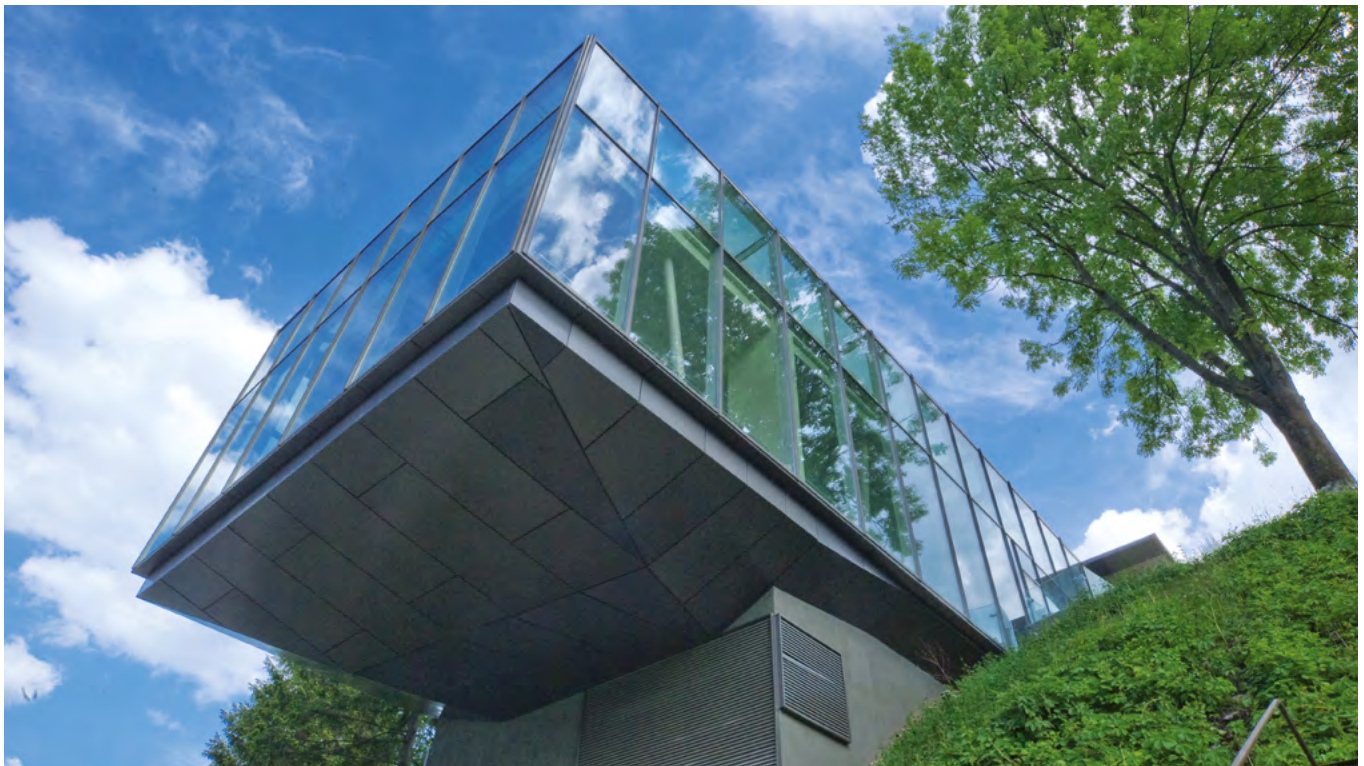

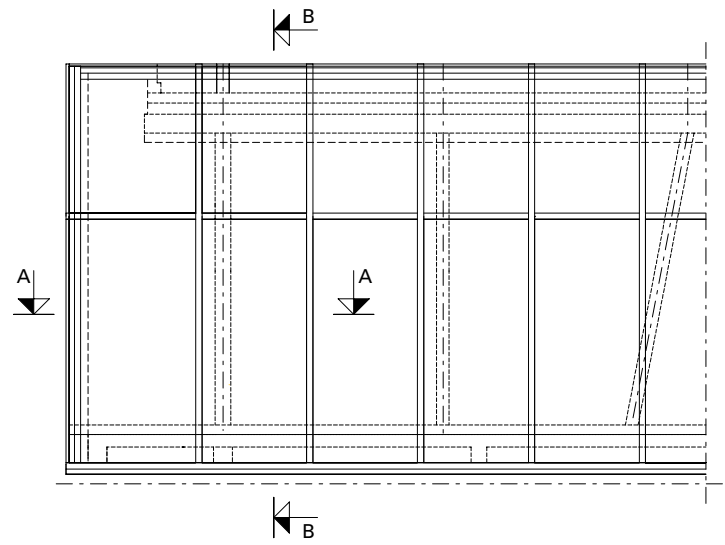
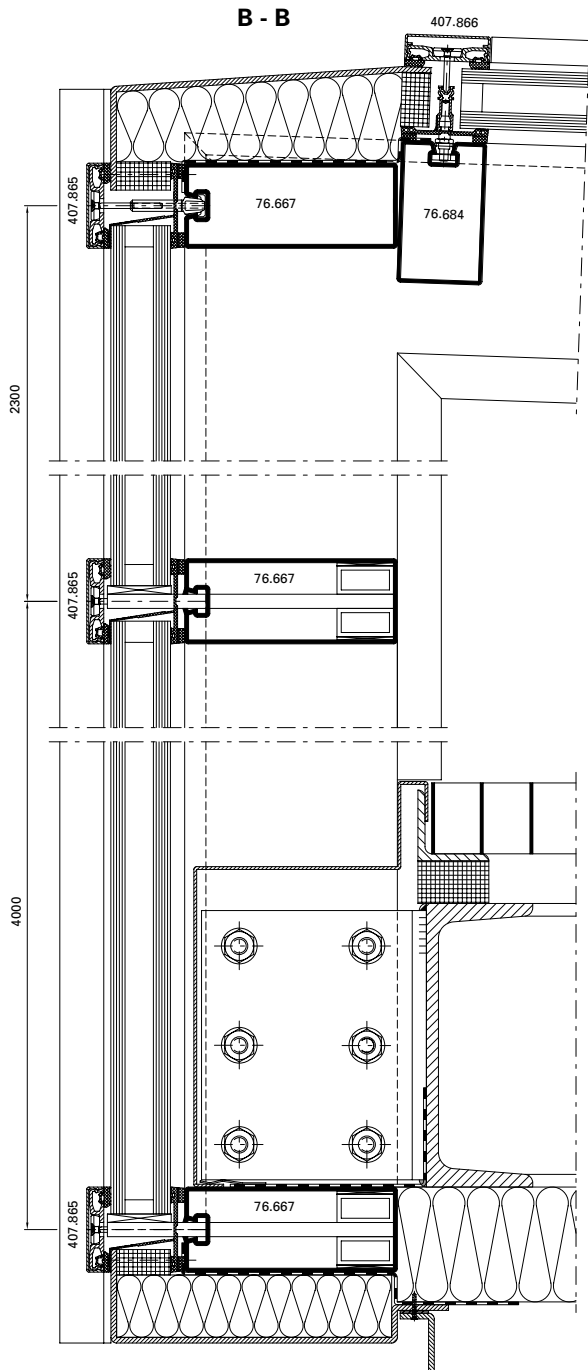

Ausgeführte Objekte

Objets réalisés

Completed projects

Objekt:

Hotel Novi Spa,
Novi Vinodolski/HR

System:

VISS TV Linea

Architekt:

Architekturstudio Banas und Cimas,
Rijeka/HR

Objet:

Hôtel Novi Spa,
Novi Vinodolski/HR

Système:

VISS TV Linea

Architecte:

Architekturstudio Banas und Cimas,
Rijeka/HR

Project:

Novi Spa Hotel,
Novi Vinodolski/HR

System:

VISS TV Linea

Architect:

Architekturstudio Banas und Cimas,
Rijeka/HR



Objekt:

Solvias AG, Büro- und Lagergebäude, Kaiseraugst/CH

System:

VISS TV Linea

Architekt:

Zwimpfer Partner Architekten, Basel/CH

Objet:

Solvias AG, immeuble de bureaux et d'entrepôt, Kaiseraugst/CH

Système:

VISS TV Linea

Architecte:

Zwimpfer Partner Architekten, Bâle/CH

Project:

Solvias AG, office and warehouse facility, Kaiseraugst/CH

System:

VISS TV Linea

Architect:

Zwimpfer Partner Architekten, Basle/CH



Ausgeführte Objekte

Objets réalisés

Completed projects

Objekt:

Médiathèque, Pau/FR

System:

VISS Fire EW60, VISS Basic,
Janisol 3 E160

Architekt:

CANAL, Paris/FR

Objet:

Médiathèque, Pau/FR

Système:

VISS Fire EW60, VISS Basic,
Janisol 3 E160

Architecte:

CANAL, Paris/FR

Project:

Médiathèque, Pau/FR

System:

VISS Fire EW60, VISS Basic,
Janisol 3 E160

Architect:

CANAL, Paris/FR



A - A

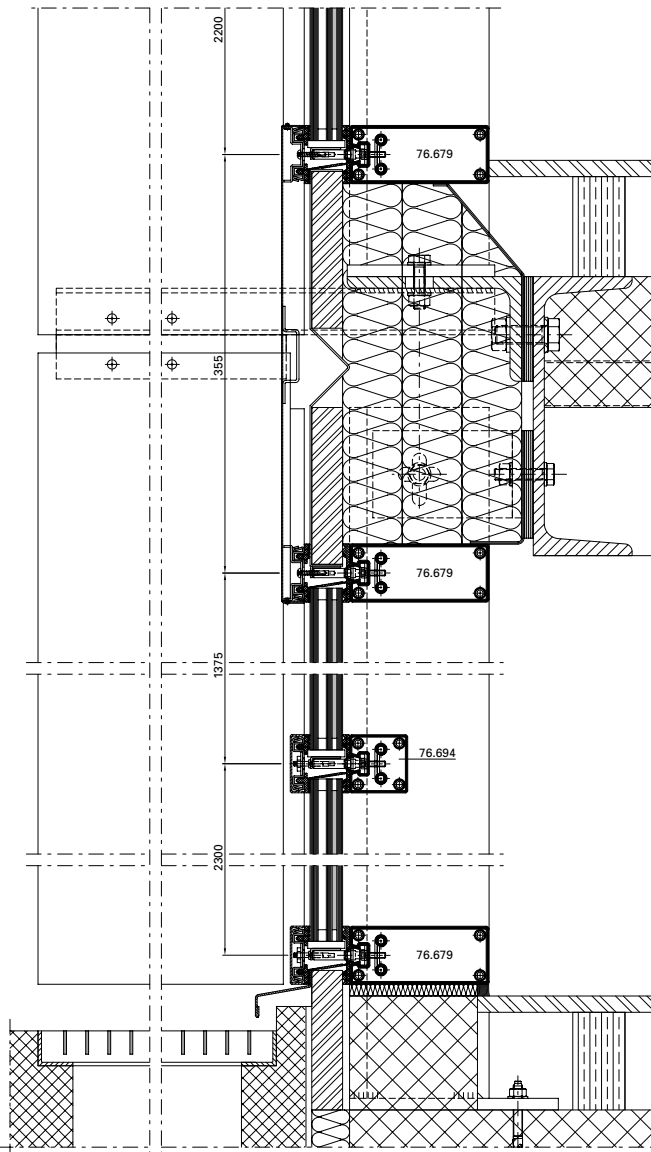

B - B

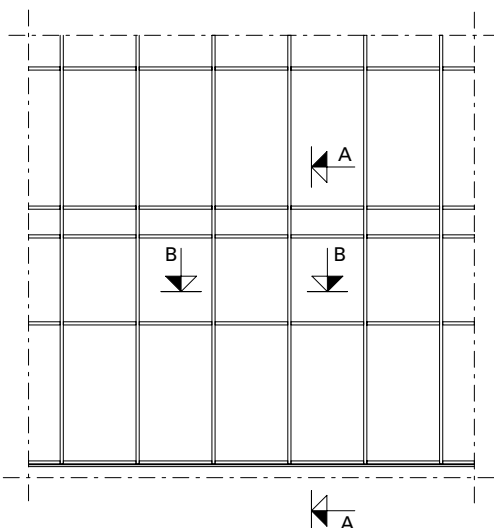
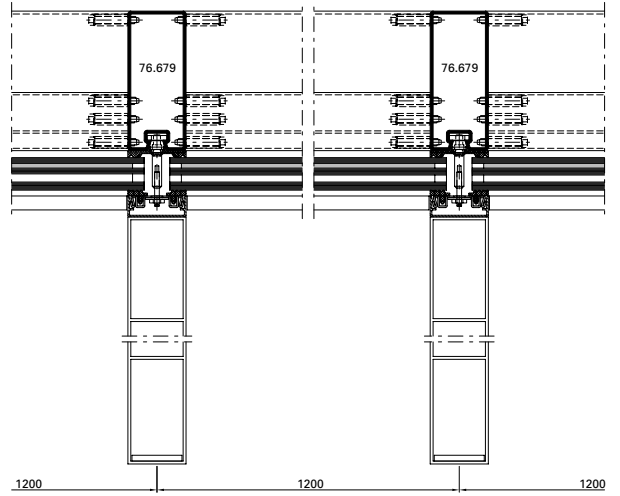

Ausgeführte Objekte

Objets réalisés

Completed projects

Objekt:

«Mumuth» Haus für Musik & Musiktheater der Kunstuniversität, Graz/AT

System:

VISS TVS

Architekt:

UNStudio, Arch. Ben van Berkel en Bos, Amsterdam/NL

Objet:

«Mumuth» Maison de la musique & du théâtre musical de l'université des arts, Grace/AT

Système:

VISS TVS

Architecte:

UNStudio, Arch. Ben van Berkel en Bos, Amsterdam/NL

Project:

«Mumuth» House of Music & Music Drama at the University of Music and Performing Arts, Graz/AT

System:

VISS TVS

Architect:

UNStudio, Arch. Ben van Berkel en Bos, Amsterdam/NL



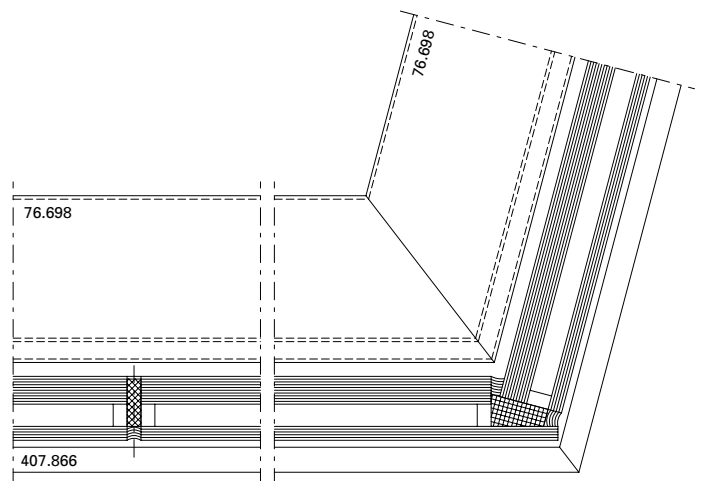
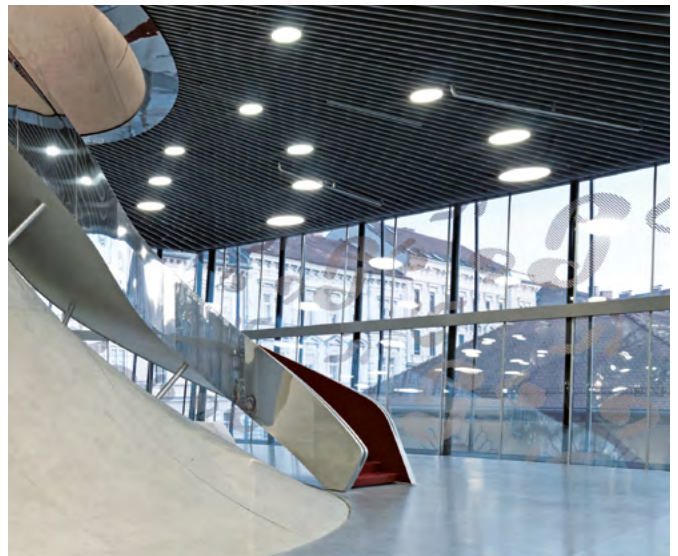
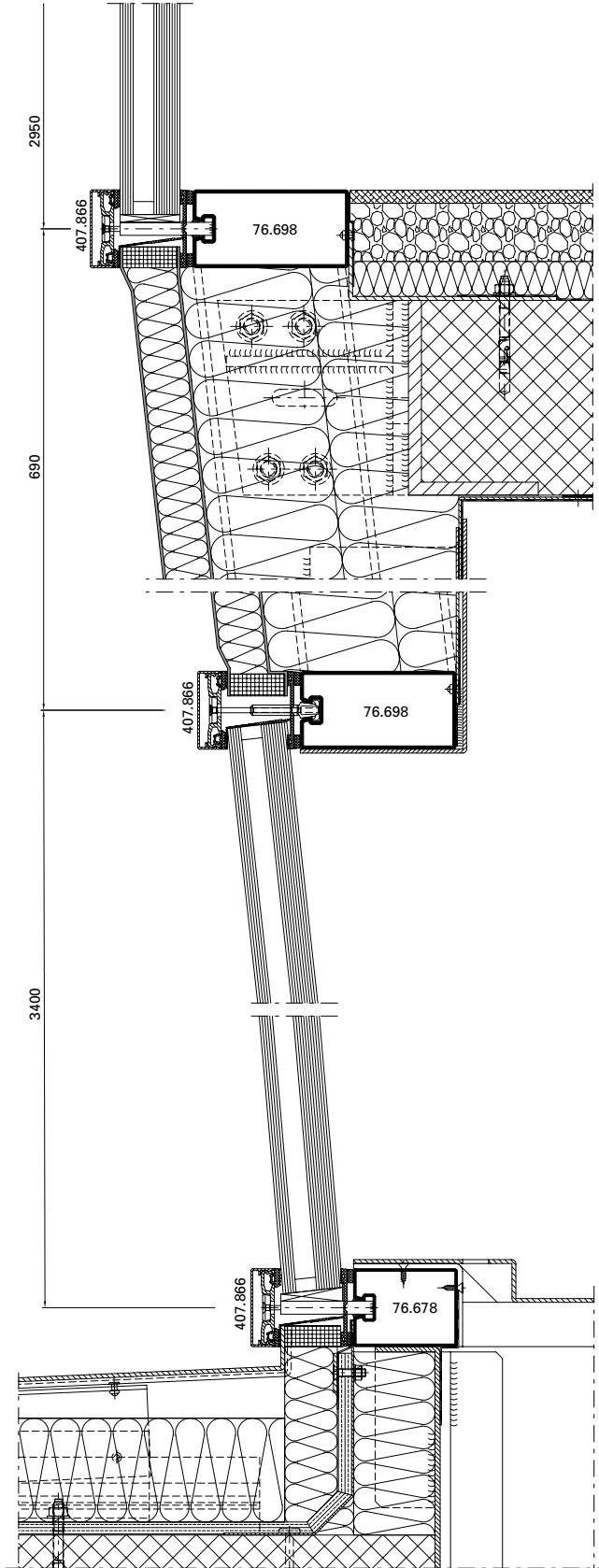

Ausgeführte Objekte
Objets réalisés
Completed projects



Project:

Centre Pompidou, Metz/FR

System:

VISS Fire EI60,
Jansen-Economy 50 E30

Architect:

Shigeru Ban Architects, Paris/FR

Objet:

Centre Pompidou, Metz/FR

Système:

VISS Fire EI60,
Jansen-Economy 50 E30

Architecte:

Shigeru Ban Architects, Paris/FR

Objekt:

Centre Pompidou, Metz/FR

System:

VISS Fire EI60,
Jansen-Economy 50 E30

Architekt:

Shigeru Ban Architects, Paris/FR



Objekt:

Alters- und Pflegeheim,
Burgdorf/CH

System:

VISS Basic TV

Architekt:

Gauer Itten Messerli Architekten AG,
Bern/CH

Objet:

Home pour personnes âgées, Burgdorf/
CH

Système:

VISS Basic TV

Architecte:

Gauer Itten Messerli Architekten AG,
Bern/CH

Project:

Old-age and nursing home, Burgdorf/
CH

System:

VISS Basic TV

Architect:

Gauer Itten Messerli Architekten AG,
Bern/CH

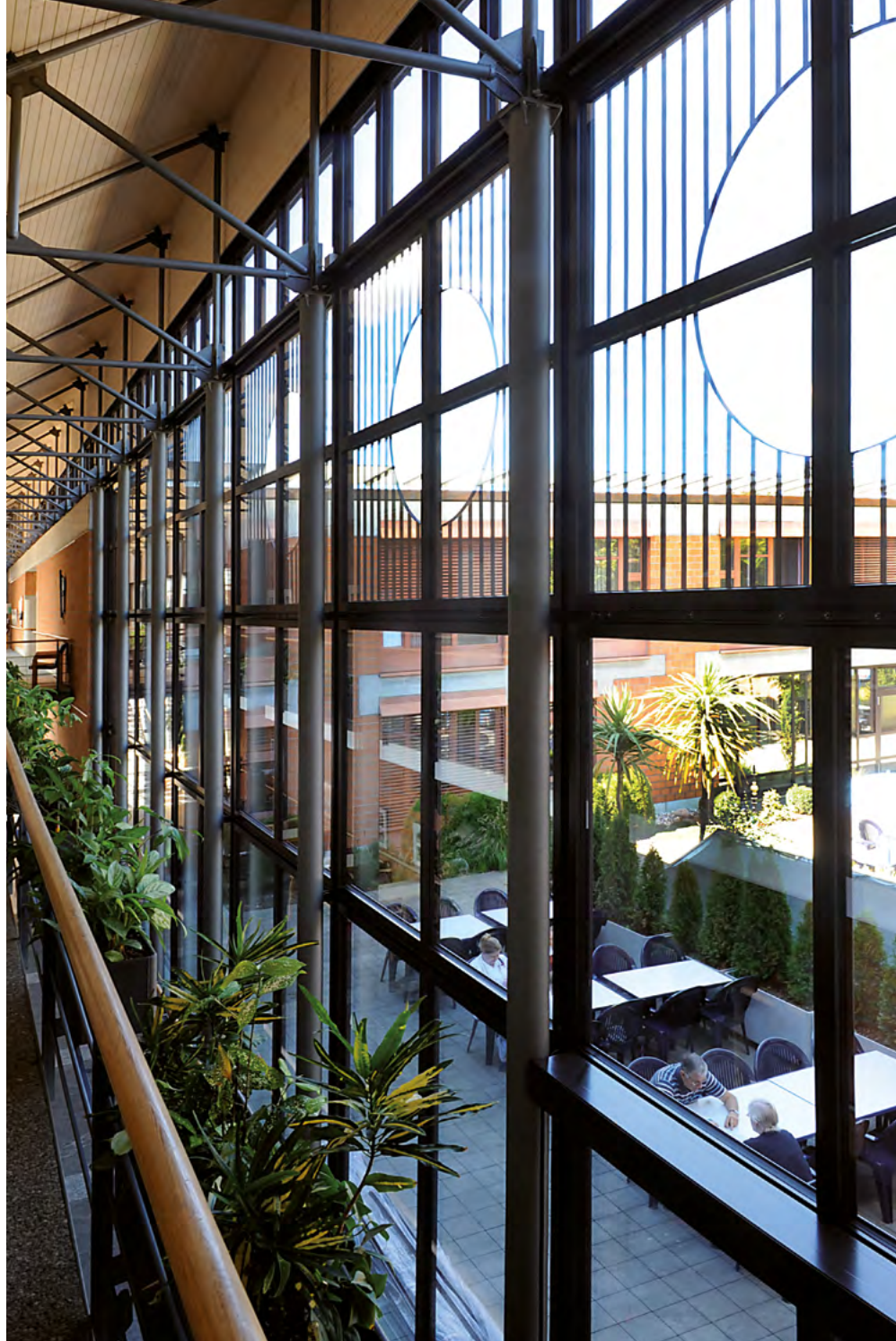

Ausgeführte Objekte Objets réalisés Completed projects

Objekt:

Drents Museum, Assen/NL

System:

VISS Basic TV,
Jansen-Economy 50 EW60

Architekt:

Designed by Erick van Egeraat,
Rotterdam/NL

Objet:

Musée Drents, Assen/NL

Système:

VISS Basic TV,
Jansen-Economy 50 EW60

Architecte:

Designed by Erick van Egeraat,
Rotterdam/NL

Project:

Drents Museum, Assen/NL

System:

VISS Basic TV,
Jansen-Economy 50 EW60

Architect:

Designed by Erick van Egeraat,
Rotterdam/NL



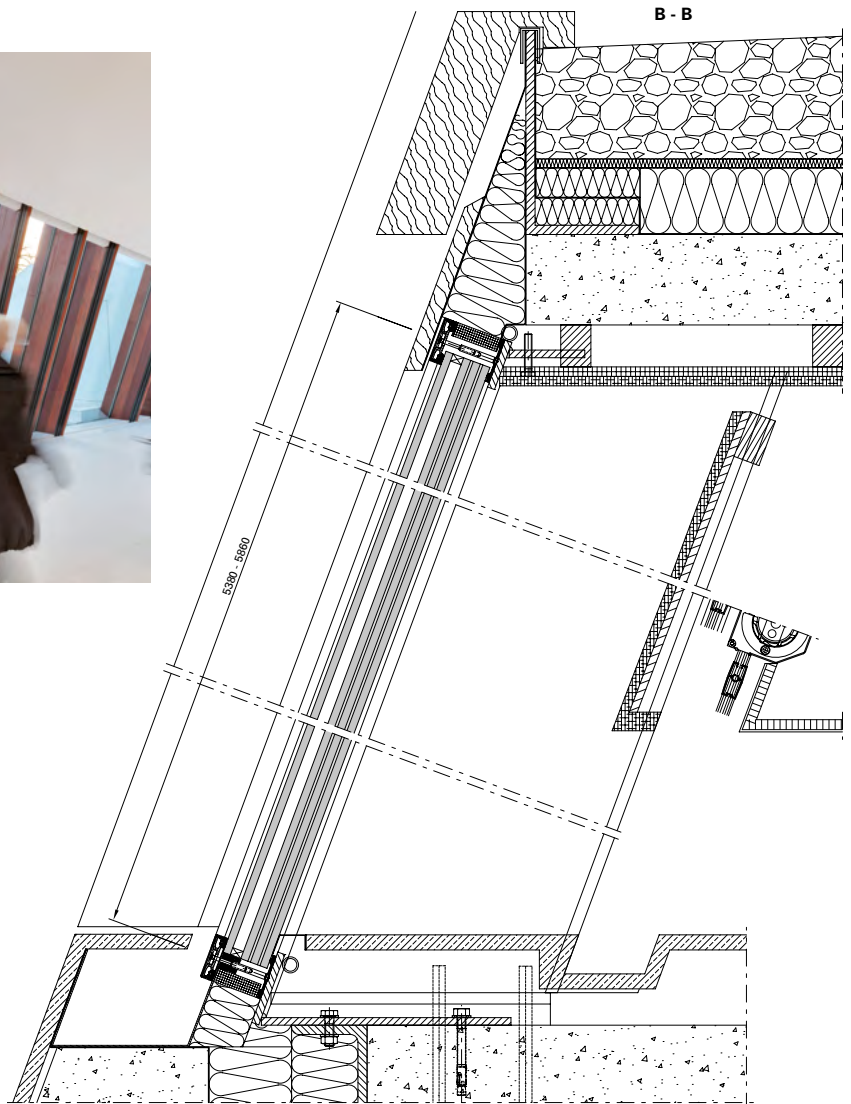
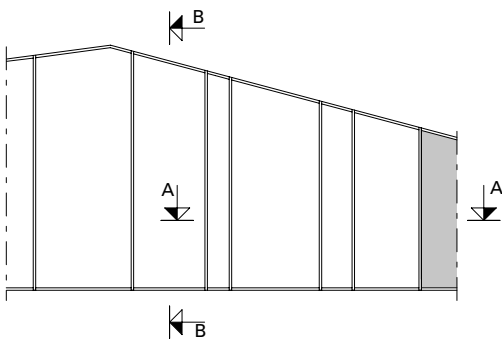
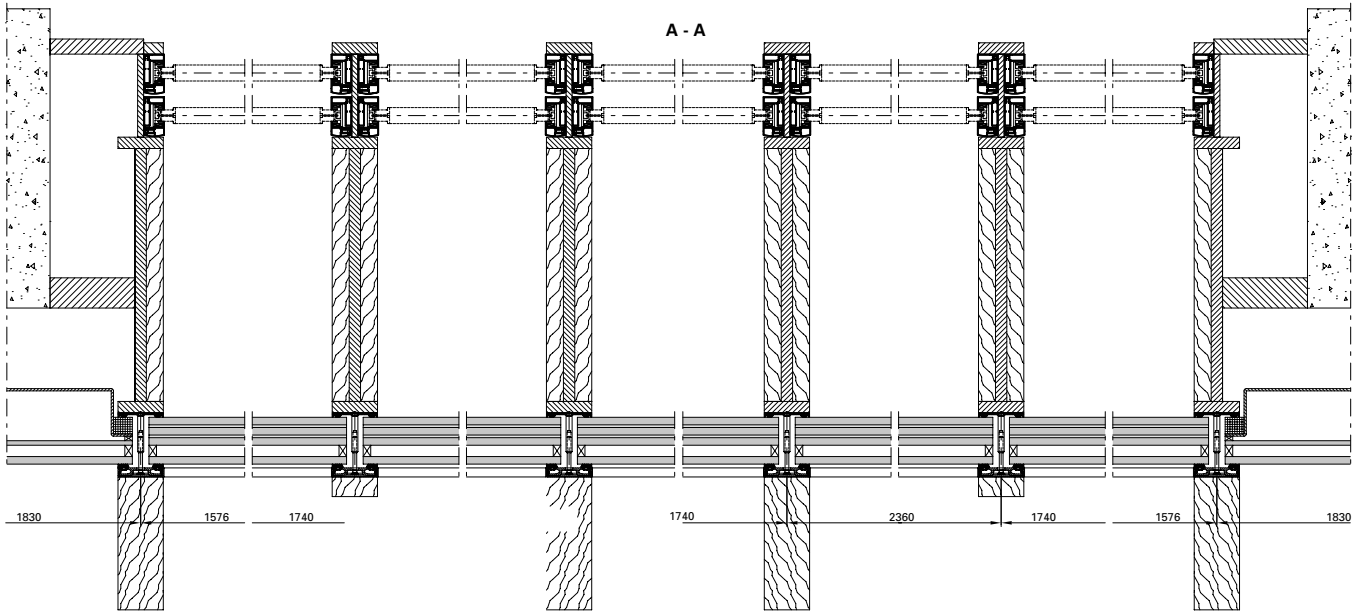

Ausgeführte Objekte Objets réalisés Completed projects

Objekt:

Akkustik-Tunnels,
Warschau/PL

System:

VISS Basic TVS (schräg)

Architekt:

Transprojekt, Warschau/PL
FOROOM Bartłomiej Grotte,
Warschau/PL

Objet:

Tunnels acoustiques,
Varsovie/PL

Système:

VISS Basic TVS (oblique)

Architecte:

Transprojekt, Varsovie/PL
FOROOM Bartłomiej Grotte,
Varsovie/PL

Project:

Acoustic tunnels,
Warsaw/PL

System:

VISS Basic TVS (sloping)

Architect:

Transprojekt, Warsaw/PL
FOROOM Bartłomiej Grotte,
Warsaw/PL

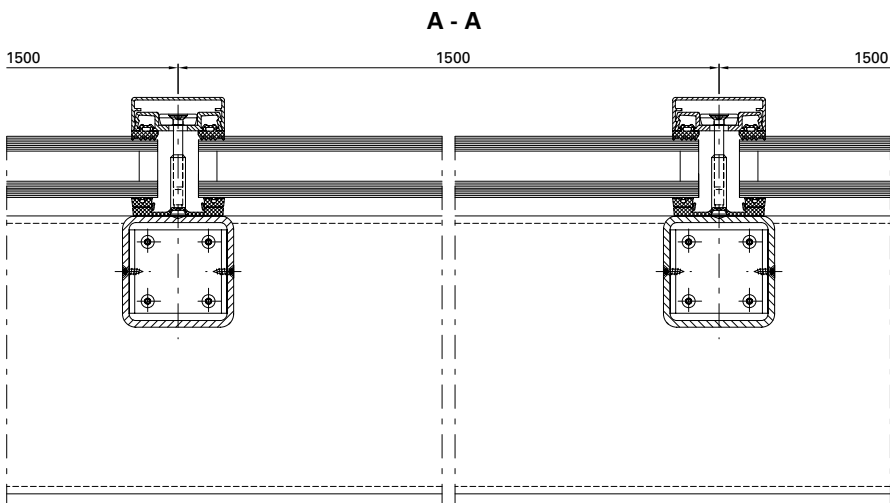

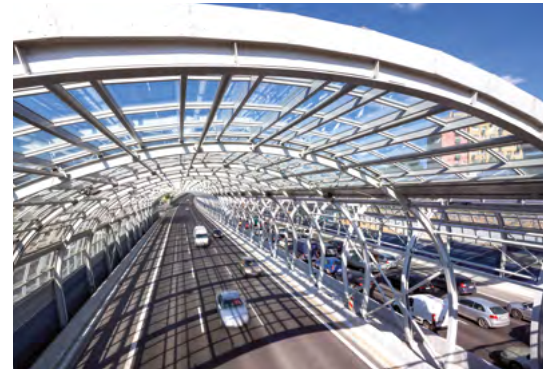
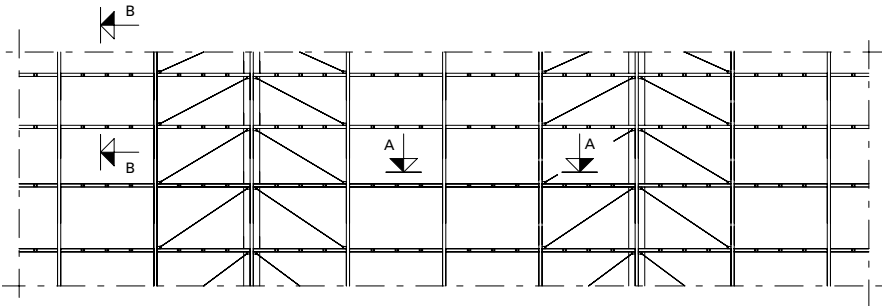
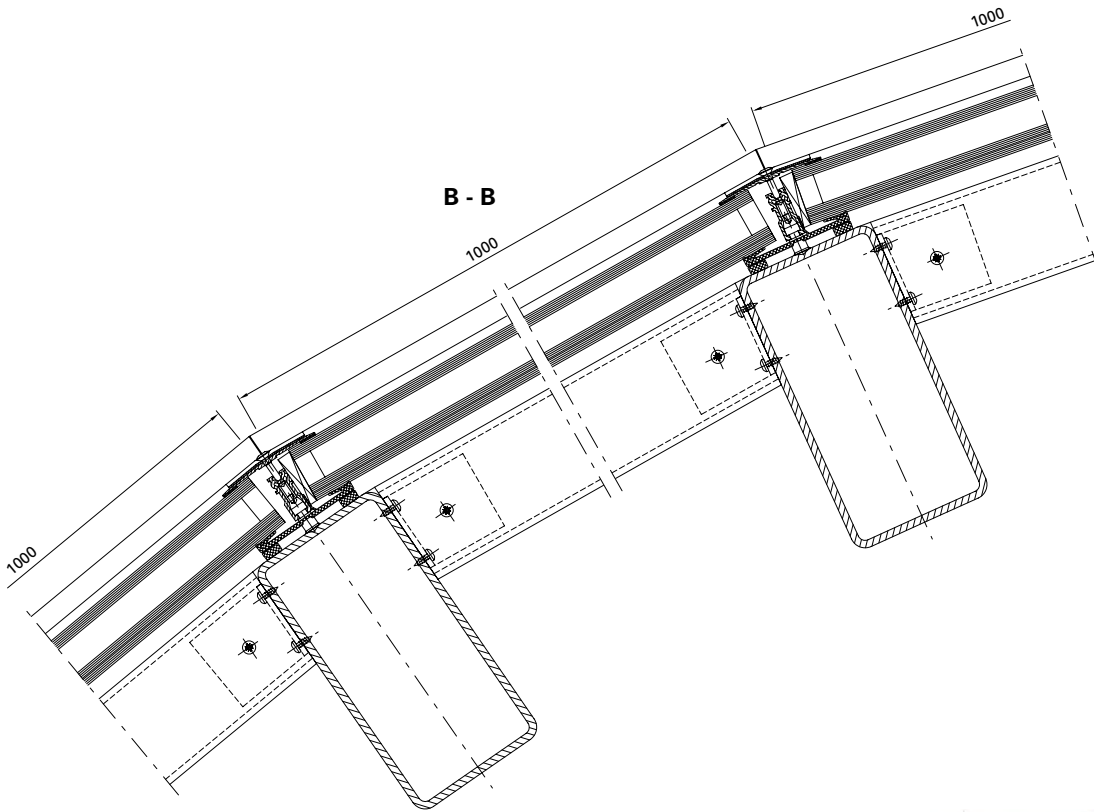

Ausgeführte Objekte

Objets réalisés

Completed projects

Objekt:

Jin Ji Hu Kempinski Hotel, Suzhou/CN

System:

VISS TV

Architekt:

Suzhou Architecture and Design
Institute, Shanghai/CN

Objet:

Hôtel Jin Ji Hu Kempinski, Suzhou/CN

Système:

VISS TV

Architecte:

Suzhou Architecture and Design
Institute, Shanghai/CN

Project:

Jin Ji Hu Kempinski Hotel, Suzhou/CN

System:

VISS TV

Architect:

Suzhou Architecture and Design
Institute, Shanghai/CN



Objekt:

Historisches Museum,
Kharkov/UA

System:

VISS I_xtra, Janisol Türen

Architekt:

S. Chechelnytskiy, M. Polivanova,
T. Polivanova, Kharkov/UA

Objet:

Musée historique,
Kharkov/UA

Système:

VISS I_xtra, portes Janisol

Architecte:

S. Chechelnytskiy, M. Polivanova,
T. Polivanova, Kharkov/UA

Project:

Historical museum,
Kharkov/UA

System:

VISS I_xtra, Janisol doors

Architect:

S. Chechelnytskiy, M. Polivanova,
T. Polivanova, Kharkov/UA

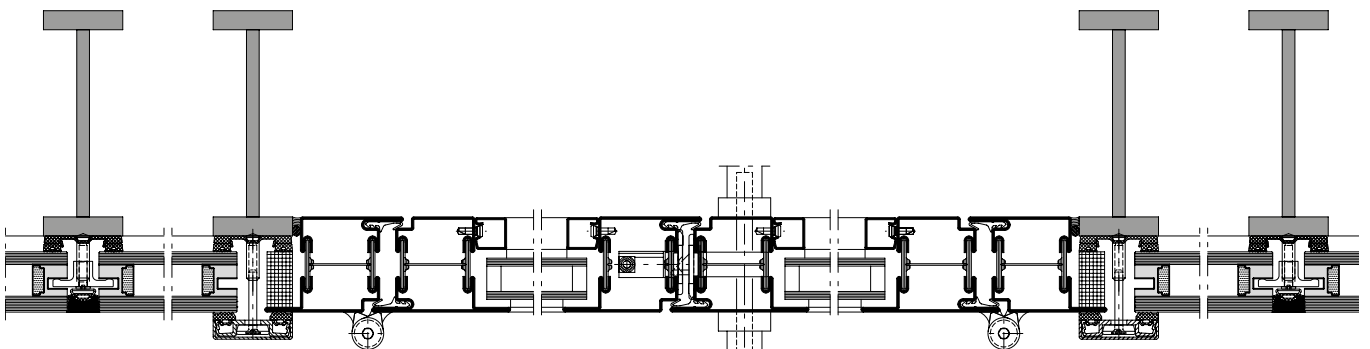

Ausgeführte Objekte

Objets réalisés

Completed projects

Objekt:

Kunstgebäude, Stuttgart/DE

System:

VISS TVS (schräg)

Architekt:

Harder III Stumpf, Freie Architekten,
Stuttgart/DE

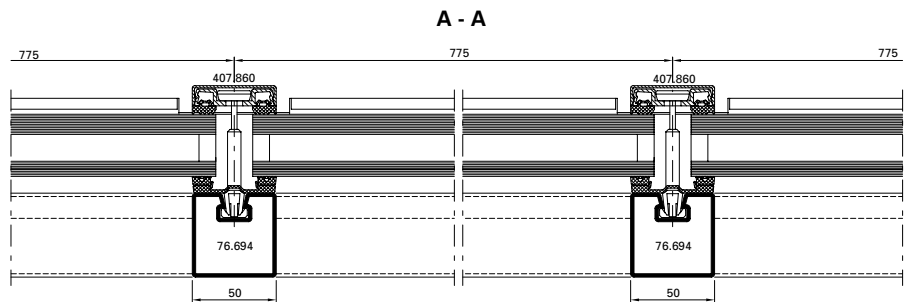

Objet:

Bâtiment des arts, Stuttgart/DE

Système:

VISS TVS (oblique)

Architecte:

Harder III Stumpf, Freie Architekten,
Stuttgart/DE

Project:

Art building, Stuttgart/DE

System:

VISS TVS (sloping)

Architect:

Harder III Stumpf, Freie Architekten,
Stuttgart/DE



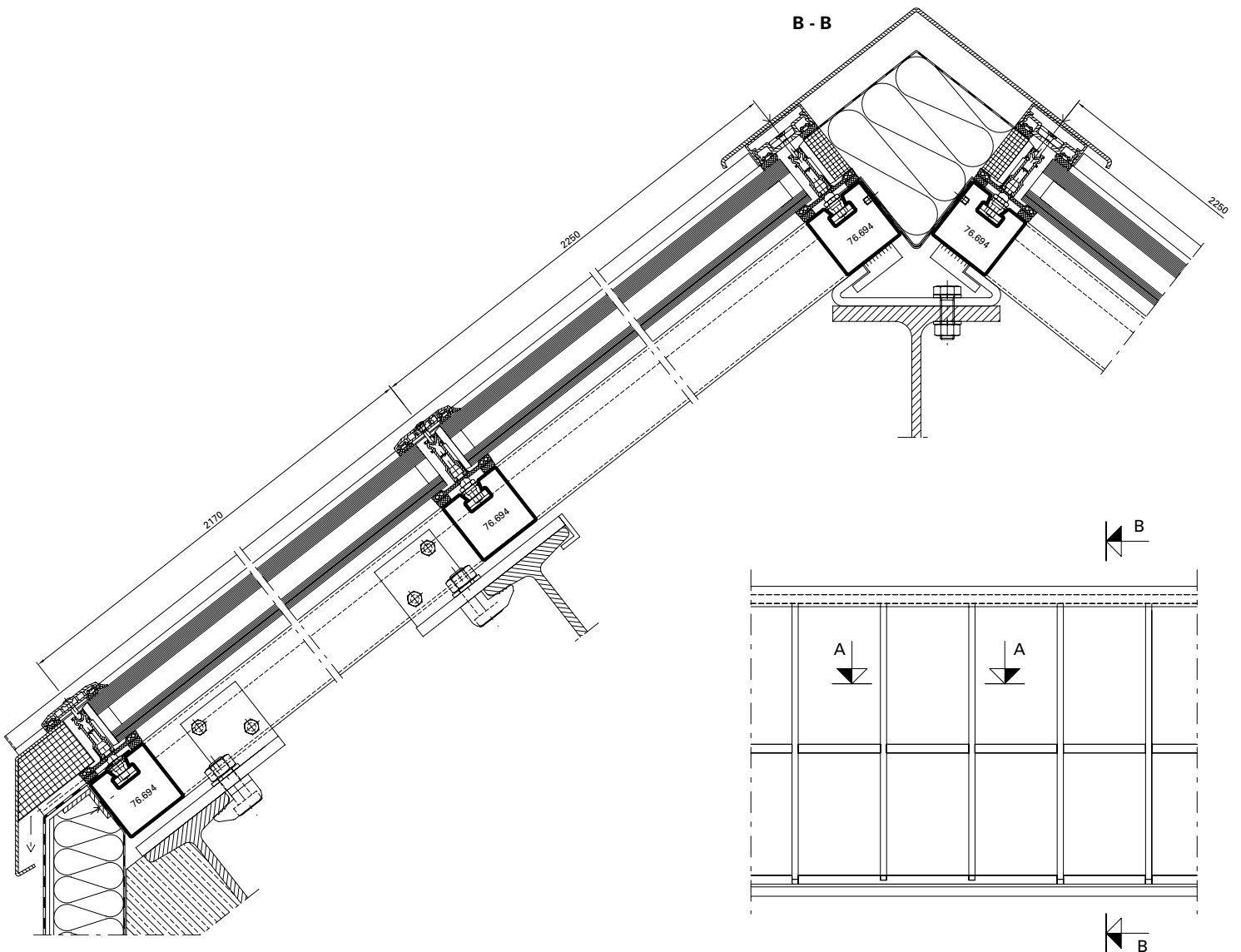

Ausgeführte Objekte

Objets réalisés

Completed projects

Objekt:

3-Feldsporthalle, Ingelfingen/DE

System:

VISS TVS HI, VISS Fire E30/E90,
Janisol Primo, Janisol Türen,
Janisol 2 E130, Jansen-Economy 60

Architekt:

Hein, Hüttel und Lindenberger,
Ludwigsburg/DE

Objet:

Salle de sport triple, Ingelfingen/DE

Système:

VISS TVS HI, VISS Fire E30/E90,
Janisol Primo, portes Janisol,
Janisol 2 E130, Jansen-Economy 60

Architecte:

Hein, Hüttel und Lindenberger,
Ludwigsburg/DE

Project:

3-field sports hall, Ingelfingen/DE

System:

VISS TVS HI, VISS Fire E30/E90,
Janisol Primo, Janisol doors,
Janisol 2 E130, Jansen-Economy 60

Architect:

Hein, Hüttel und Lindenberger,
Ludwigsburg/DE

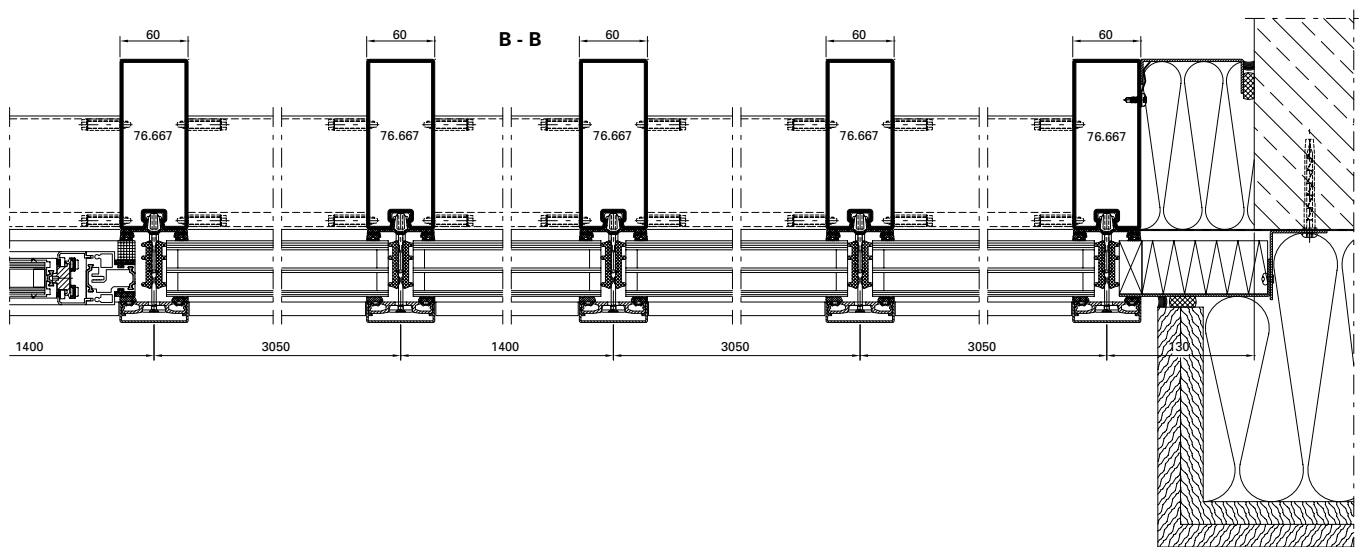

A - A

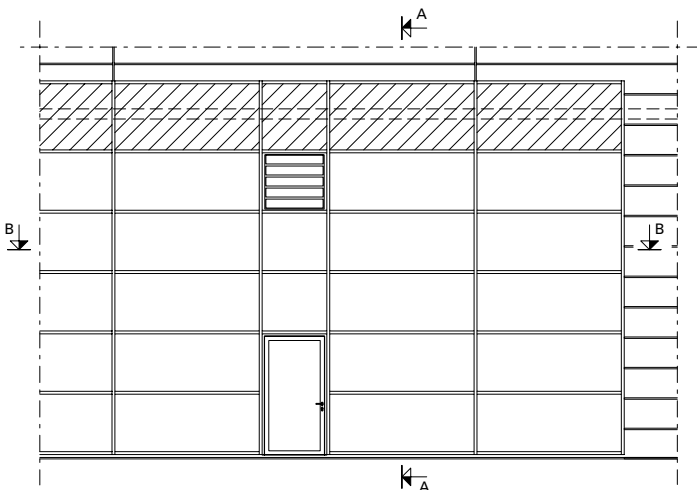
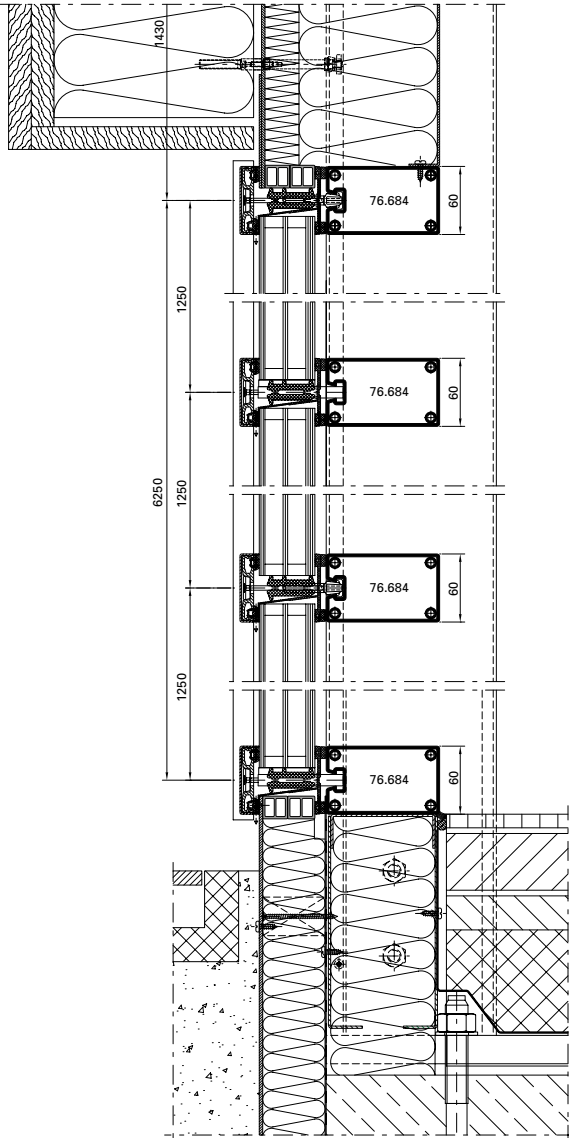

Ausgeführte Objekte

Objets réalisés

Completed projects

Objekt:

Musikkonservatorium, Bilbao/ES

System:

VISS TVS

Architekt:

Roberto Ercilla Arquitectura,
Vitoria/ES

Objet:

Conservatoire de musique, Bilbao/ES

Système:

VISS TVS

Architecte:

Roberto Ercilla Arquitectura,
Vitoria/ES

Project:

Conservatory of Music, Bilbao/ES

System:

VISS TVS

Architect:

Roberto Ercilla Arquitectura,
Vitoria/ES

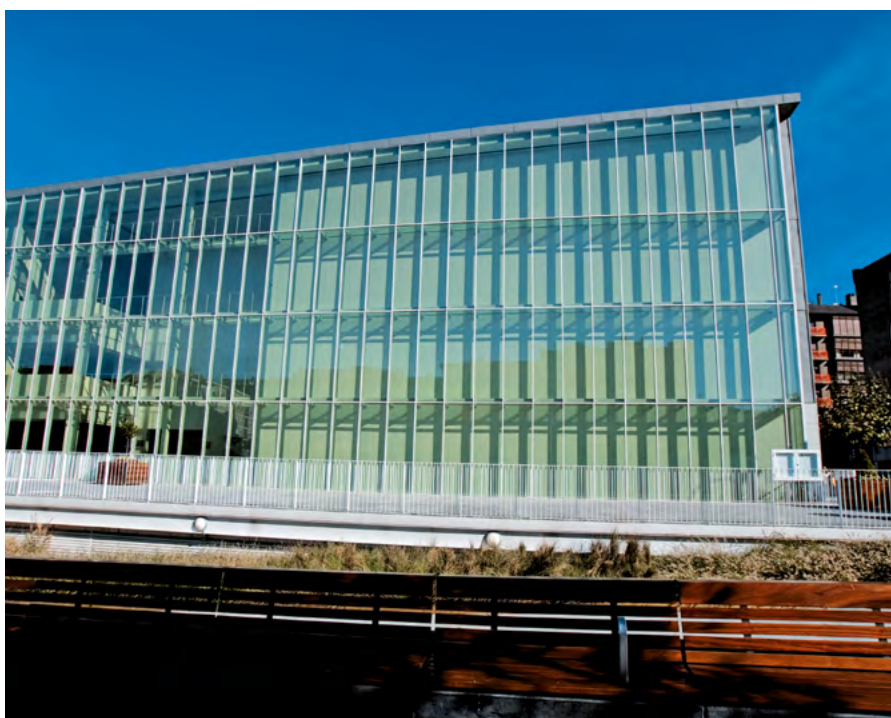
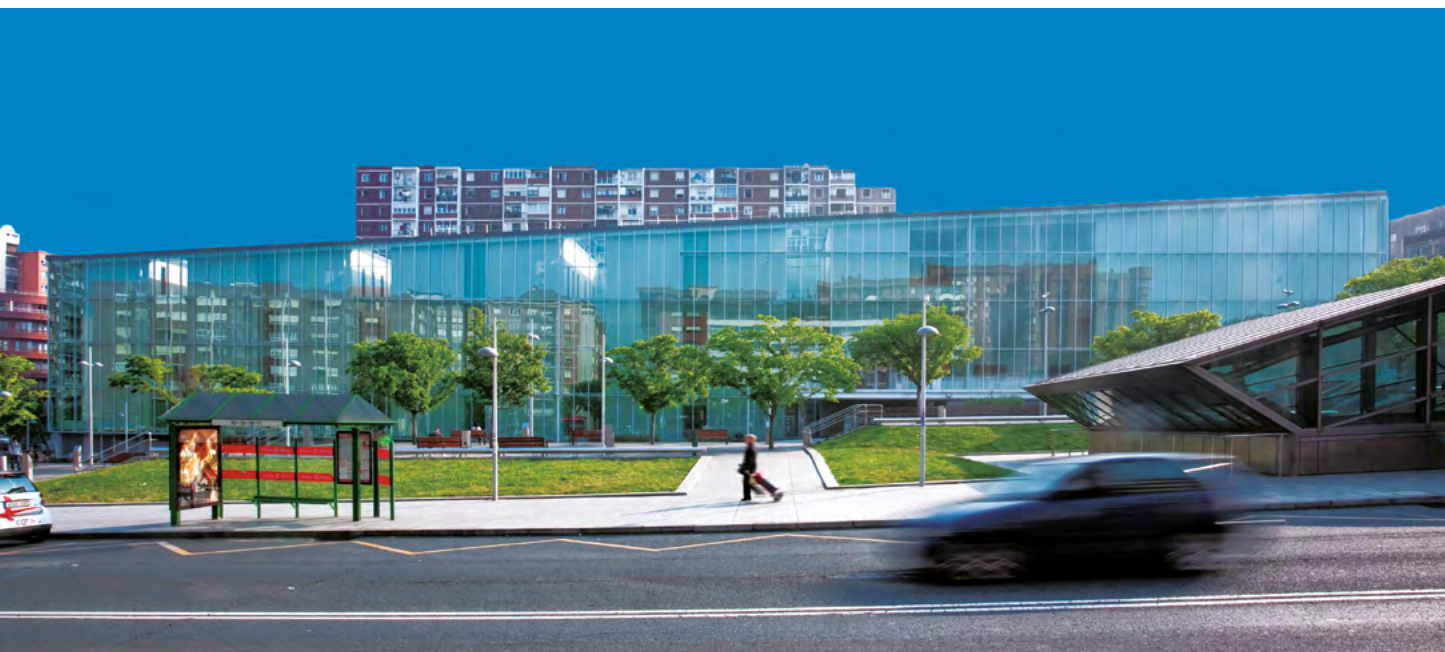

Objekt:

Landesberufsschule, Mureck/AT

System:

VISS TVS Linea

Architekt:

Architekten Domenig & Wallner
ZT GmbH, Graz/AT

Objet:

École professionnelle, Mureck/AT

Système:

VISS TVS Linea

Architecte:

Architekten Domenig & Wallner
ZT GmbH, Graz/AT

Project:

State vocational school, Mureck/AT

System:

VISS TVS Linea

Architect:

Architekten Domenig & Wallner
ZT GmbH, Graz/AT



Ausgeführte Objekte
Objets réalisés
Completed projects



Fotos: Jochen Helle, Dortmund

Objekt:

Hafencity Schule, Hamburg/DE

System:

VISS Fire E30 TVS vertikal und schräg,
Janisol Türen

Architekt:

Spengler-Wiescholek Architekten,
Hamburg/DE

Objet:

École Hafencity, Hamburg/DE

Système:

VISS Fire E30 TVS vertical et oblique,
Portes Janisol

Architecte:

Spengler-Wiescholek Architekten,
Hamburg/DE

Project:

Hafencity school, Hamburg/DE

System:

VISS Fire E30 TVS vertical and sloping,
Janisol doors

Architect:

Spengler-Wiescholek Architekten,
Hamburg/DE



A - A

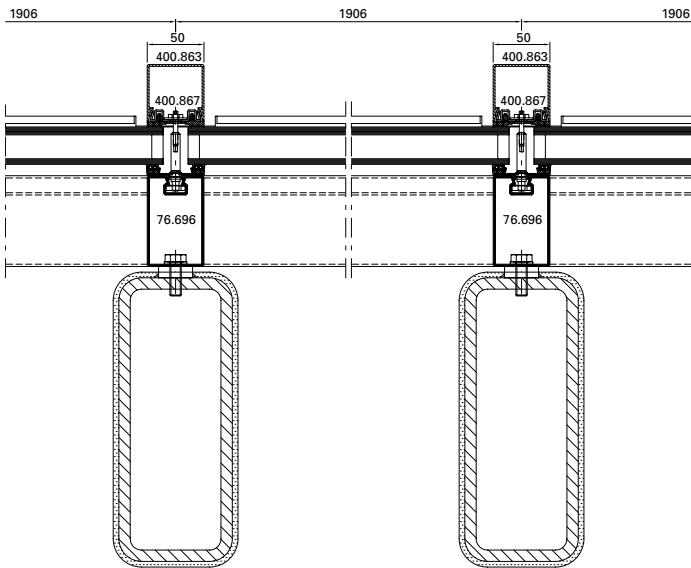

B

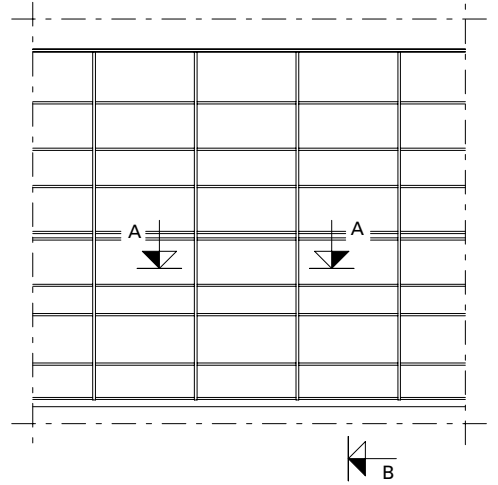

B - B

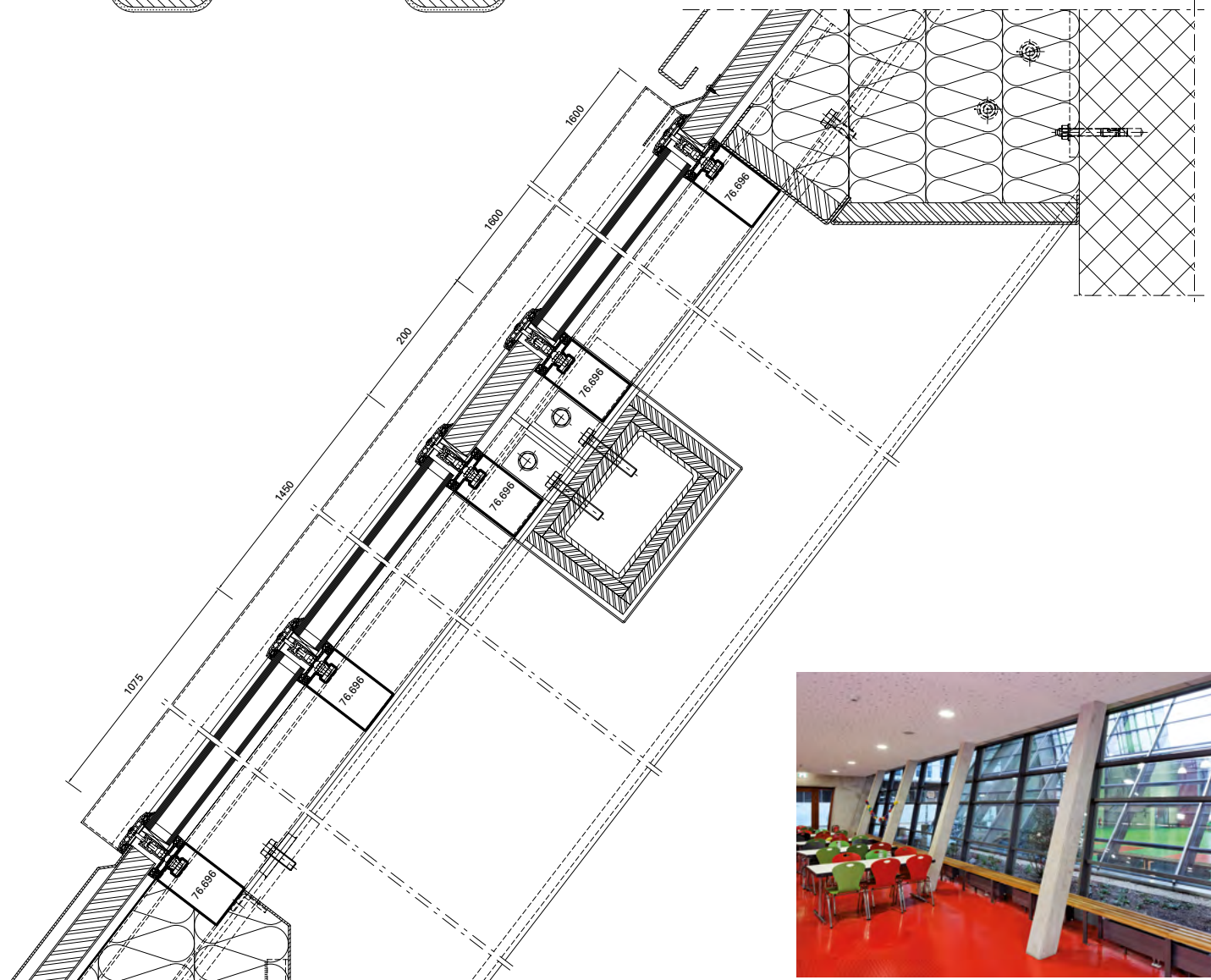

Ausgeführte Objekte

Objets réalisés

Completed projects

Objekt:

Drehrestaurant «Hoher Kasten»,
Brülisau/CH

System:

VISS Basic TVS

Architekt:

architekten : rlc ag, Rheineck/CH

Objet:

Restaurant panoramique
«Hoher Kasten», Brülisau/CH

Système:

VISS Basic TVS

Architecte:

architekten : rlc ag, Rheineck/CH

Project:

Revolving restaurant «Hoher Kasten»,
Brülisau/CH

System:

VISS Basic TVS

Architect:

architekten : rlc ag, Rheineck/CH

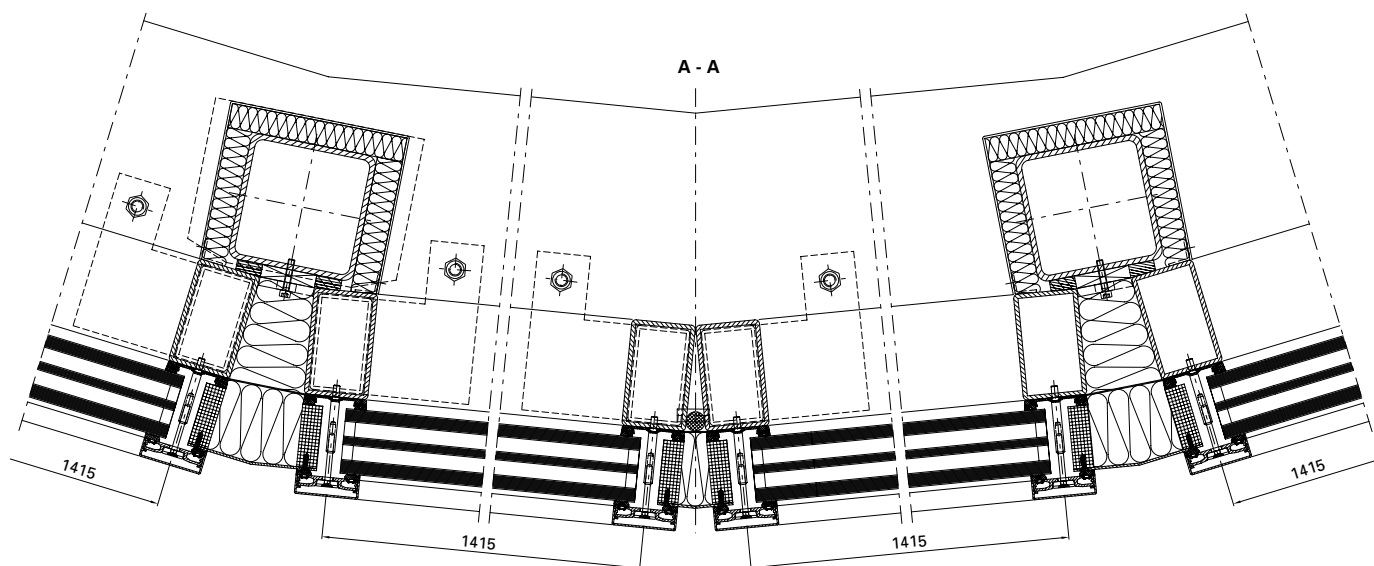

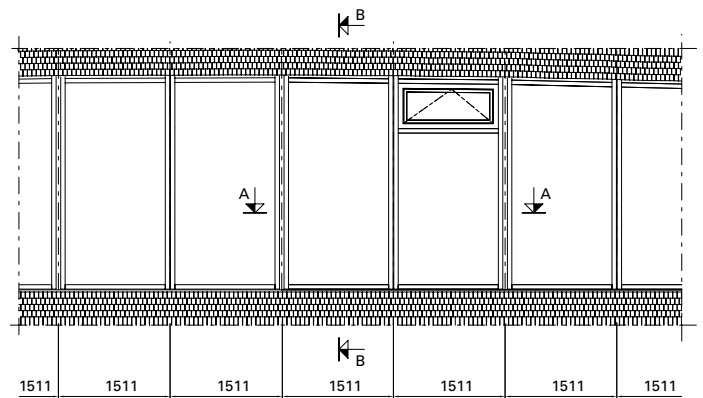
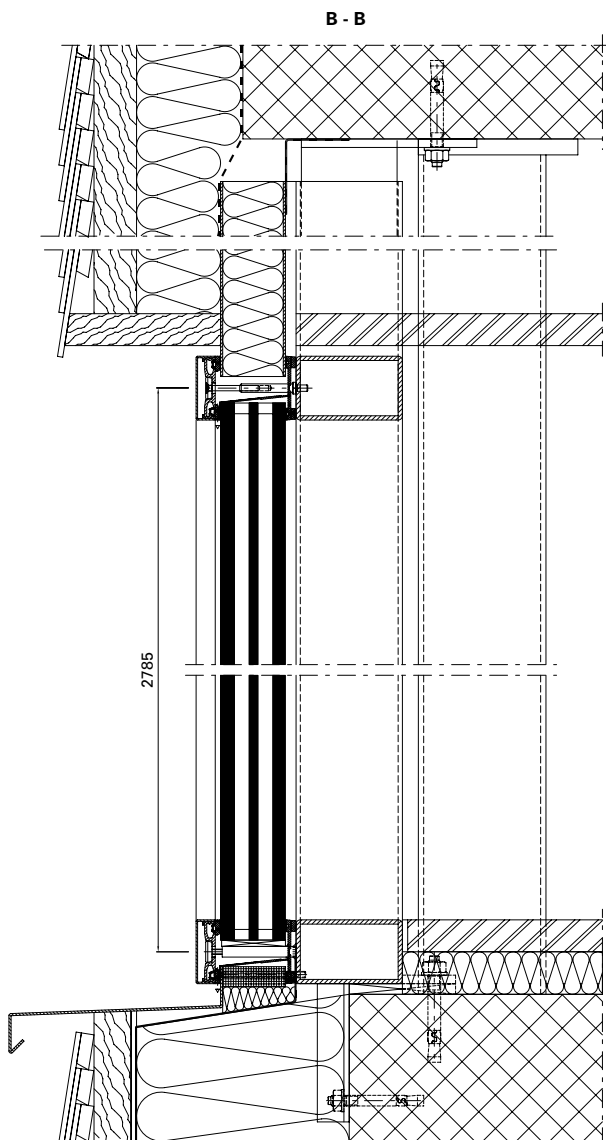

Ausgeführte Objekte

Objets réalisés

Completed projects

Objekt:

Hauptbahnhof «Rotterdam Centraal»,
Rotterdam/NL

System:

VISS Basic, VISS Fire, Janisol Türen

Architekt:

Team CS: Zusammenarbeit von
Bentham Crowel Architekten,
Meyer en Van Schooten Architecten
und West 8, Rotterdam/NL

Objet:

Gare centrale «Rotterdam Centraal»,
Rotterdam/NL

Système:

VISS Basic, VISS Fire, portes Janisol

Architecte:

Team CS: Coopération de Bentham
Crowel Architectes, Meyer en Van
Schooten Architectes et West 8,
Rotterdam/NL

Project:

Central station «Rotterdam Centraal»,
Rotterdam/NL

System:

VISS Basic, VISS Fire, Janisol doors

Architect:

Team CS: a cooperation of Bentham
Crowel Architects, Meyer en Van
Schooten Architects and West 8,
Rotterdam/NL





Ausgeführte Objekte

Objets réalisés

Completed projects

Objekt:

IGuzzini Illuminazione, Barcelona/ES

System:

VISS TVS, Janisol Fenster und Türen,
Jansen-Economy 50/60

Architekt:

Josep Mias, Mias Arquitectos ACTAR,
Barcelona/ES

Objet:

IGuzzini Illuminazione, Barcelone/ES

Système:

VISS TVS, Janisol portes et fenêtres,
Jansen-Economy 50/60

Architecte:

Josep Mias, Mias Arquitectos ACTAR,
Barcelone/ES

Project:

IGuzzini Illuminazione, Barcelona/ES

System:

VISS TVS, Janisol doors and windows,
Jansen-Economy 50/60

Architect:

Josep Mias, Mias Arquitectos ACTAR,
Barcelona/ES

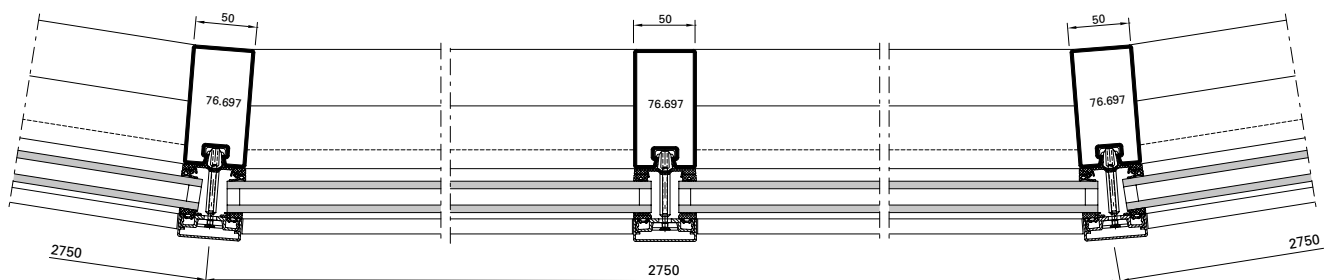

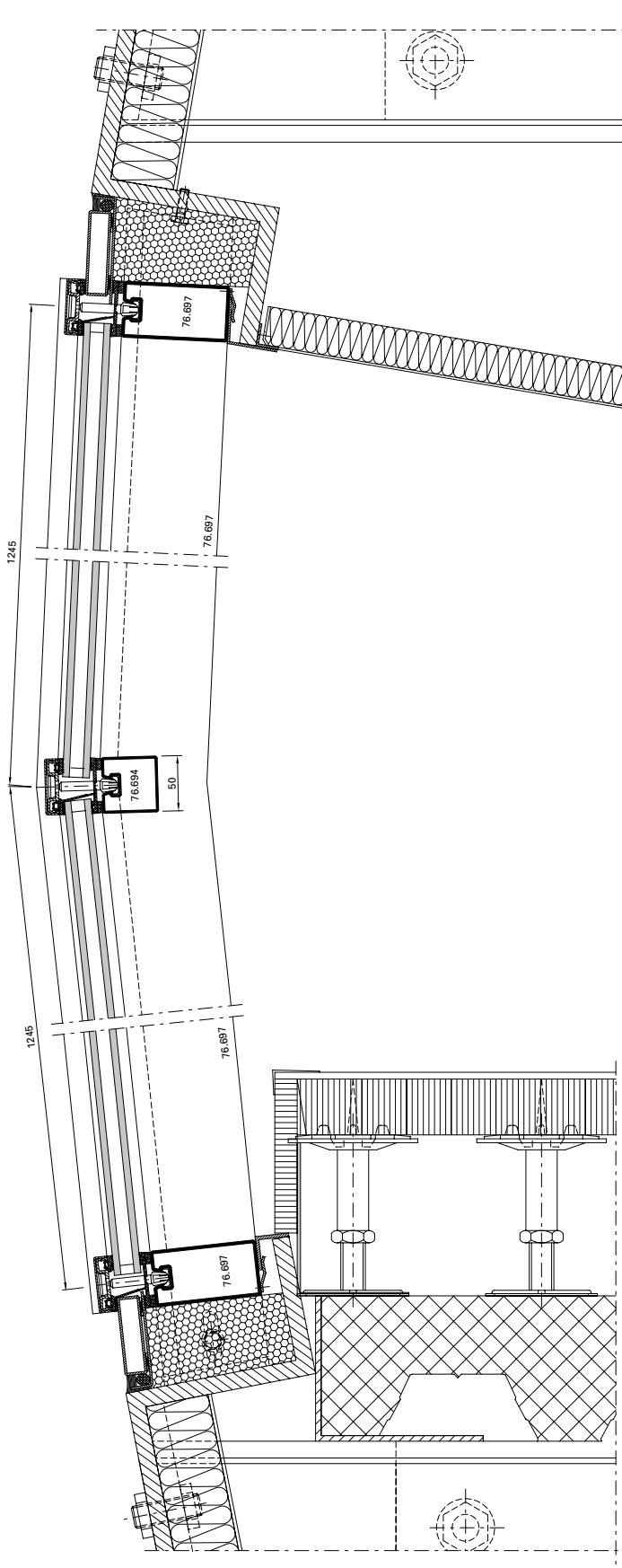

Ausgeführte Objekte

Objets réalisés

Completed projects

Objekt:

«Erasmus» Studenten-Pavillon,
Rotterdam/NL

System:

VISS I_xtra SG

Architekt:

Powerhouse Company &
DeZwarteHond, Rotterdam/NL

Objet:

Pavillon pour étudiants «Erasmus»,
Rotterdam/NL

Système:

VISS I_xtra SG

Architecte:

Powerhouse Company &
DeZwarteHond, Rotterdam/NL

Project:

«Erasmus» student pavilion,
Rotterdam/NL

System:

VISS I_xtra SG

Architect:

Powerhouse Company &
DeZwarteHond, Rotterdam/NL

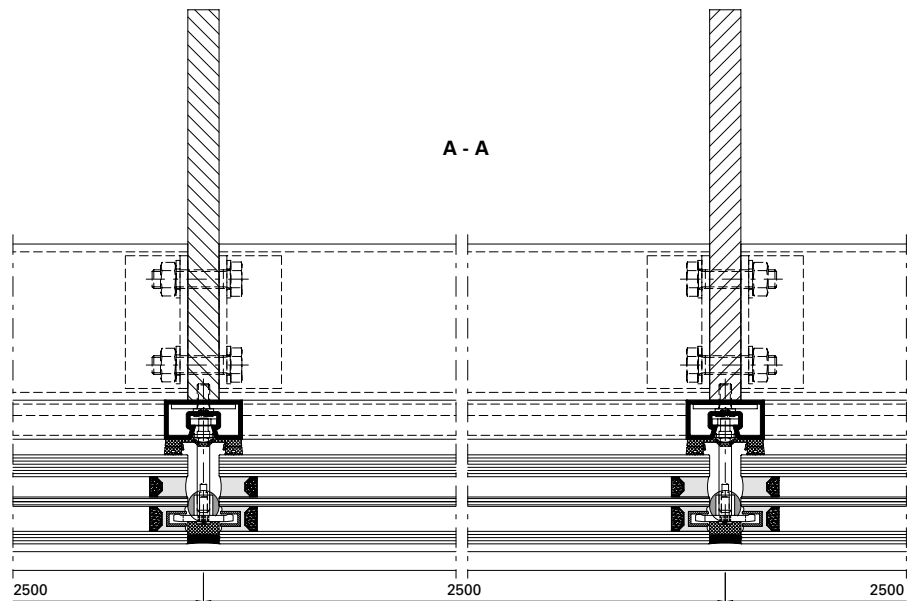

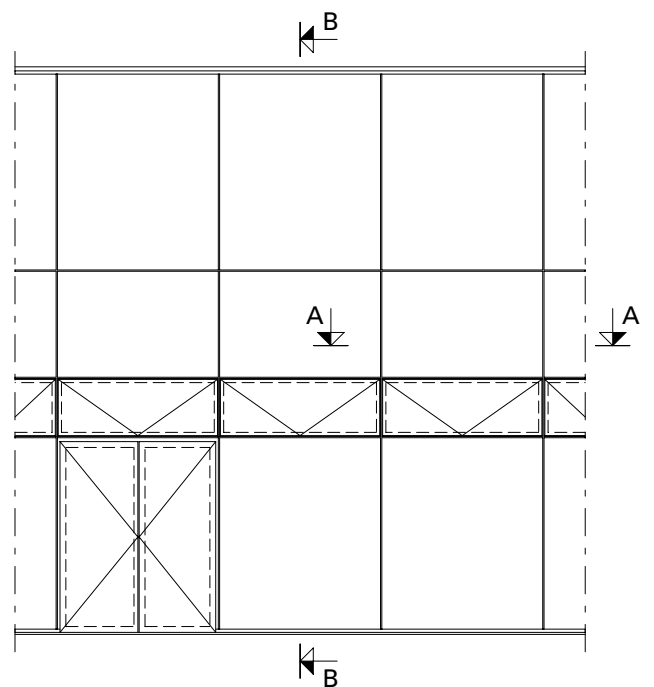
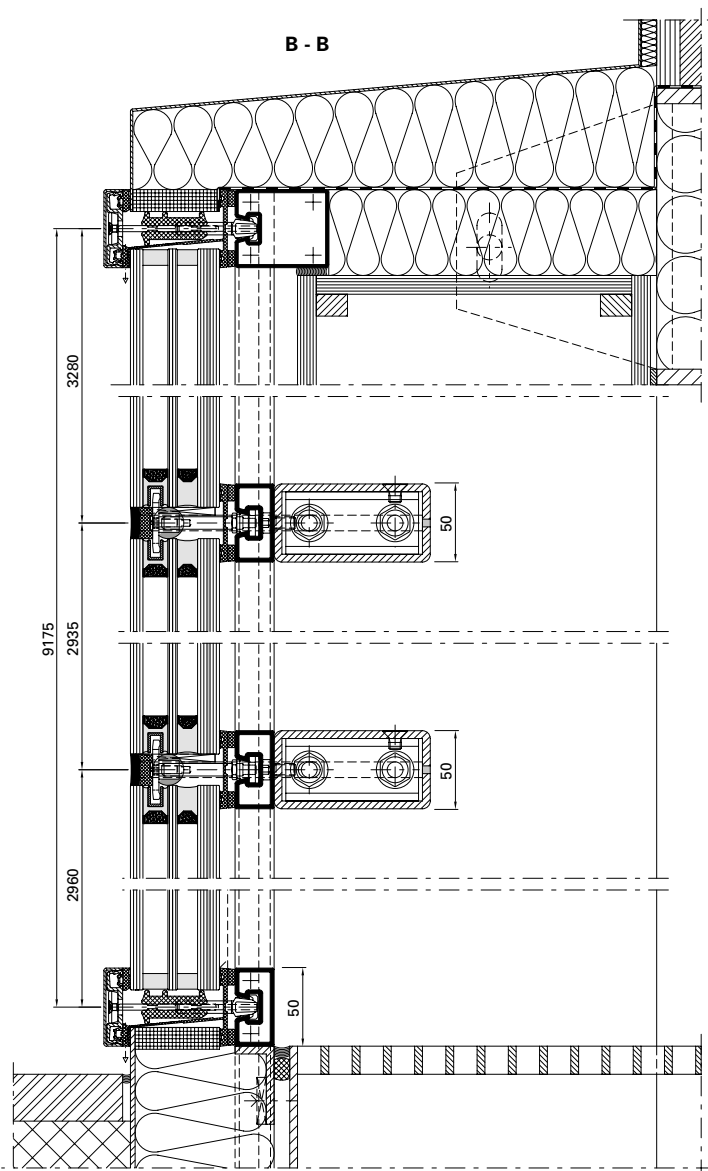
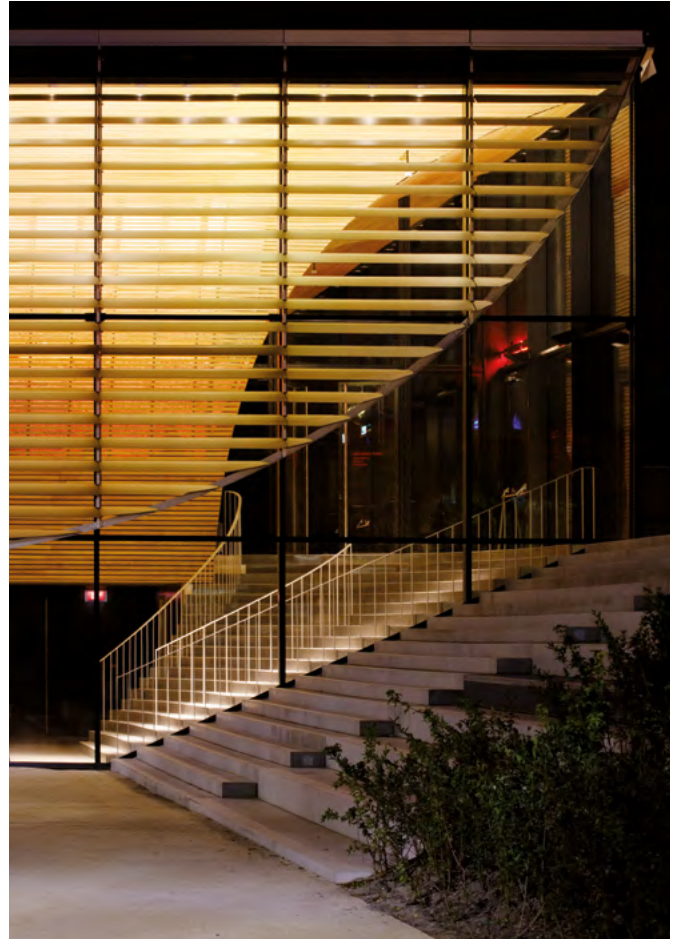

Ausgeführte Objekte
Objets réalisés
Completed projects



Fotos: Stephan Falk, Berlin

Objekt:

Hochschule «Anstalt für angewandte Wissenschaften», Dessau/DE

System:

VISS TVS

Architekt:

Kossel, Simon und Partner,
Magdeburg/DE

Objet:

École supérieure «Anstalt für angewandte Wissenschaften», Dessau/DE

Système:

VISS TVS

Architecte:

Kossel, Simon und Partner,
Magdeburg/DE

Project:

University «Anstalt für angewandte Wissenschaften», Dessau/DE

System:

VISS TVS

Architect:

Kossel, Simon und Partner,
Magdeburg/DE



Objekt:

Justizgebäude, Würzburg/DE

System:

VISS TVS, VISS Fire TVS (schräg)

Architekt:

Staatliches Bauamt Würzburg, Abt. L4, Würzburg/DE

Objet:

Palais de justice, Würzburg/DE

Système:

VISS TVS, VISS Fire TVS (oblique)

Architecte:

Staatliches Bauamt Würzburg, Abt. L4, Würzburg/DE

Project:

Law courts, Würzburg/DE

System:

VISS TVS, VISS Fire TVS (sloping)

Architect:

Staatliches Bauamt Würzburg, Abt. L4, Würzburg/DE

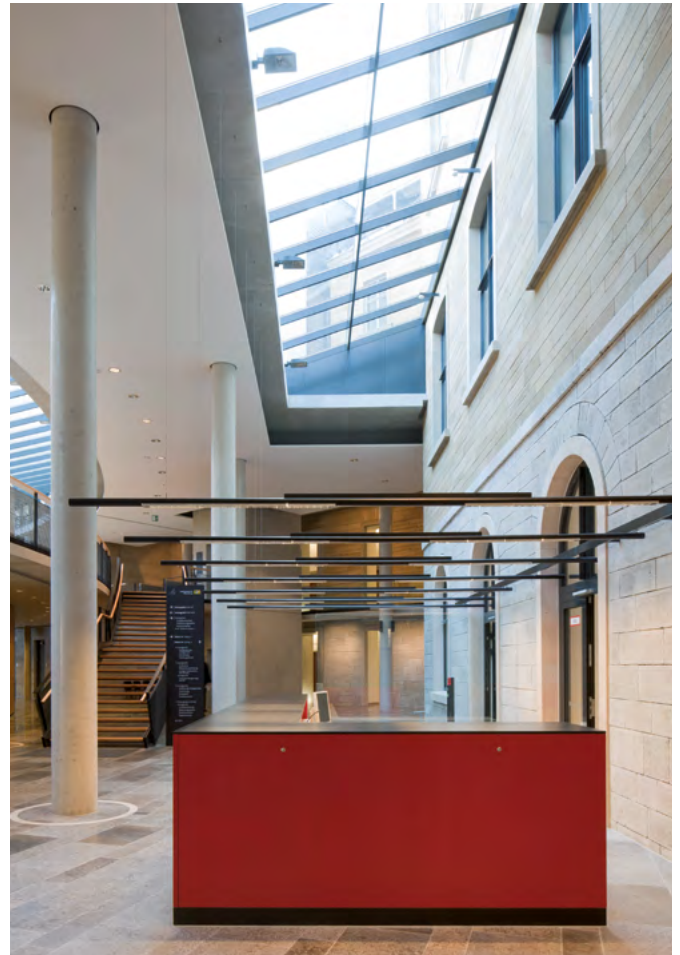

Fotos: Gerhard Hagen, Bamberg

Ausgeführte Objekte Objets réalisés Completed projects

Objekt:

Halle M, Jansen AG, Oberriet/CH

System:

VISS TVS HI

Architekt:

Göldi + Eggenberger AG,
Altstätten/CH

Objet:

Hall M, Jansen AG, Oberriet/CH

Système:

VISS TVS HI

Architecte:

Göldi + Eggenberger AG,
Altstätten/CH

Project:

Hall M, Jansen AG, Oberriet/CH

System:

VISS TVS HI

Architect:

Göldi + Eggenberger AG,
Altstätten/CH



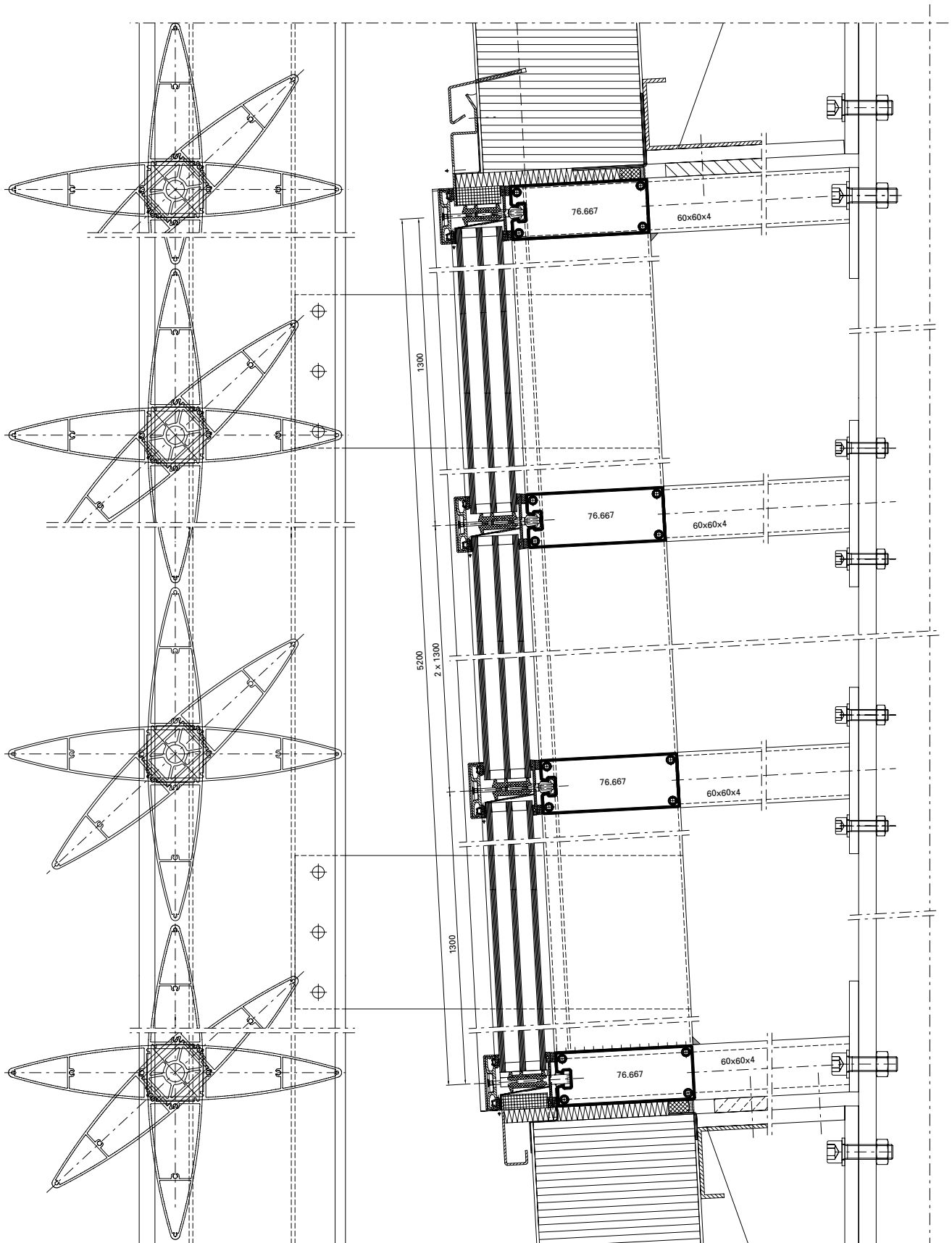

Ausgeführte Objekte
Objets réalisés
Completed projects



Fotos: Stephan Falk, Berlin

Objekt:

Vogtlandhalle (Stadthalle), Greiz/DE

System:

VISS TVS, Janisol Faltwand

Architekt:

Hoffmann.Seifert.Partner mit Ernst Scharf, Erfurt/DE

Objet:

Vogtlandhalle (salle municipale), Greiz/DE

Système:

VISS TVS, Janisol porte repliable

Architecte:

Hoffmann.Seifert.Partner mit Ernst Scharf, Erfurt/DE

Project:

Vogtland hall (city hall), Greiz/DE

System:

VISS TVS, Janisol folding wall

Architect:

Hoffmann.Seifert.Partner mit Ernst Scharf, Erfurt/DE

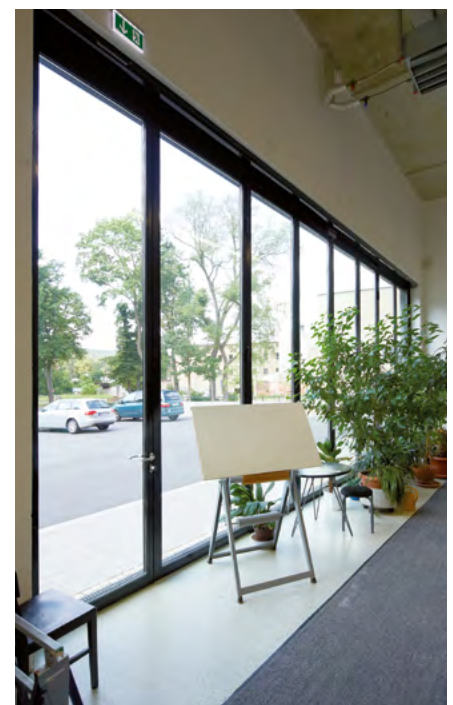
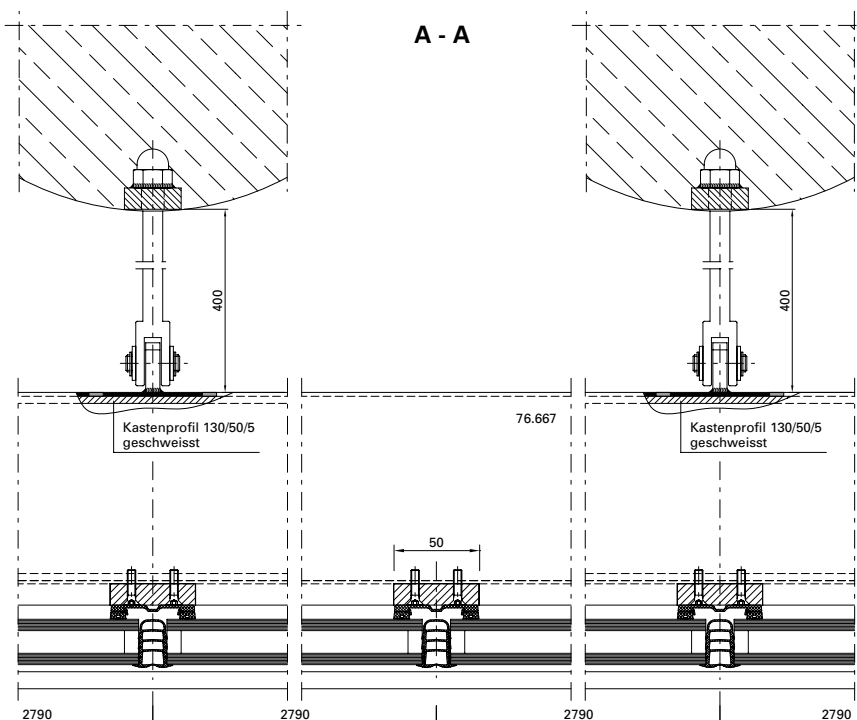

B - B

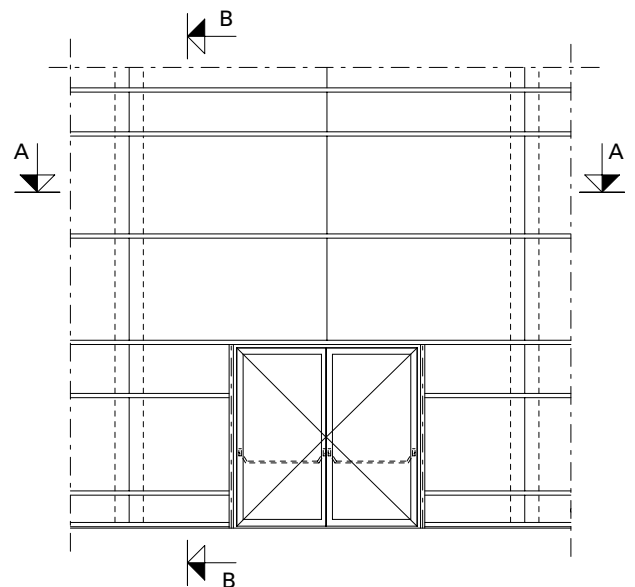
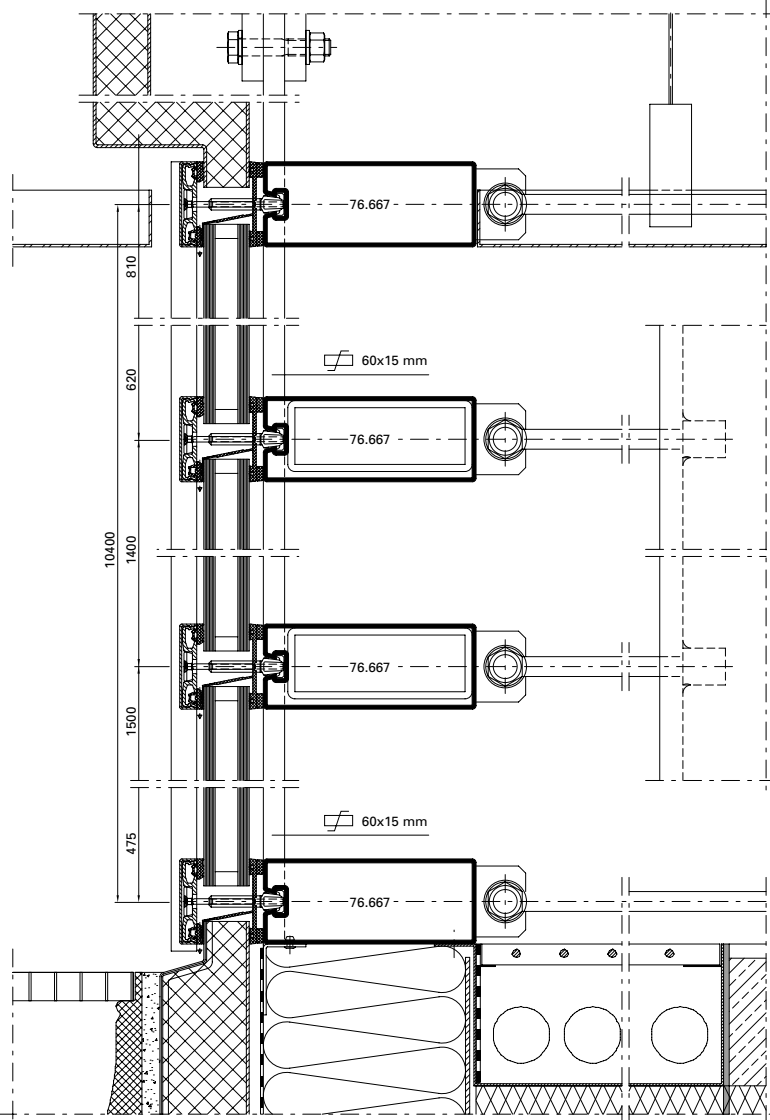

Ausgeführte Objekte

Objets réalisés

Completed projects

Objekt:

Ausbau Messehalle BEA Expo,
Bern/CH

System:

VISS Fire E30/EI30,
Jansen-Economy E30, Janisol 2 EI30

Architekt:

Schwaar & Partner AG, Bern/CH

Objet:

Agrandissement du hall d'exposition
BEA Expo, Berne/CH

Système:

VISS Fire E30/EI30,
Jansen-Economy E30, Janisol 2 EI30

Architecte:

Schwaar & Partner AG, Berne/CH

Project:

Exhibition hall extension BEA Expo,
Bern/CH

System:

VISS Fire E30/EI30,
Jansen-Economy E30, Janisol 2 EI30

Architect:

Schwaar & Partner AG, Bern/CH



Objekt:

MAN Nutzfahrzeuge, Werkserweiterung,
München/DE

System:

VISS I_xtra, Janisol Türen

Architekt:

DMP Architekten BDA, München/DE

Objet:

MAN Nutzfahrzeuge, agrandissement
de l'usine, Munich/DE

Système:

VISS I_xtra, portes Janisol

Architecte:

DMP Architekten BDA, Munich/DE

Project:

MAN Nutzfahrzeuge, plant extension,
Munich/DE

System:

VISS I_xtra, Janisol doors

Architect:

DMP Architekten BDA, Munich/DE



Ausgeführte Objekte Objets réalisés Completed projects

Objekt:

Museumsquartier, Den Bosch/NL

System:

VISS I_xtra TV

Architekt:

Bierman Henket Architecten, Esch/NL

Objet:

Quartier des musées, Den Bosch/NL

Système:

VISS I_xtra TV

Architecte:

Bierman Henket Architecten, Esch/NL

Project:

Museum Quarter, Den Bosch/NL

System:

VISS I_xtra TV

Architect:

Bierman Henket Architecten, Esch/NL



B - B

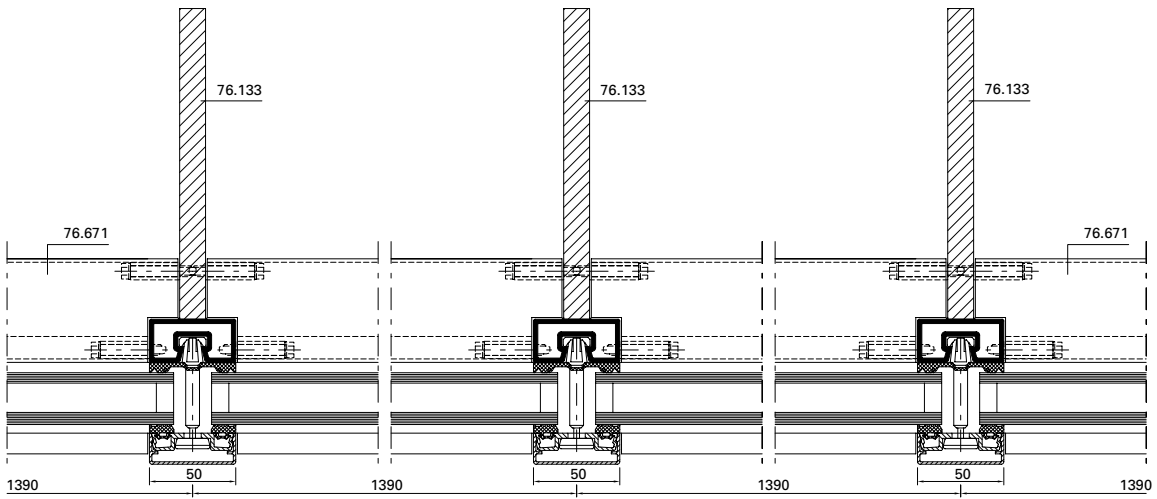

A - A

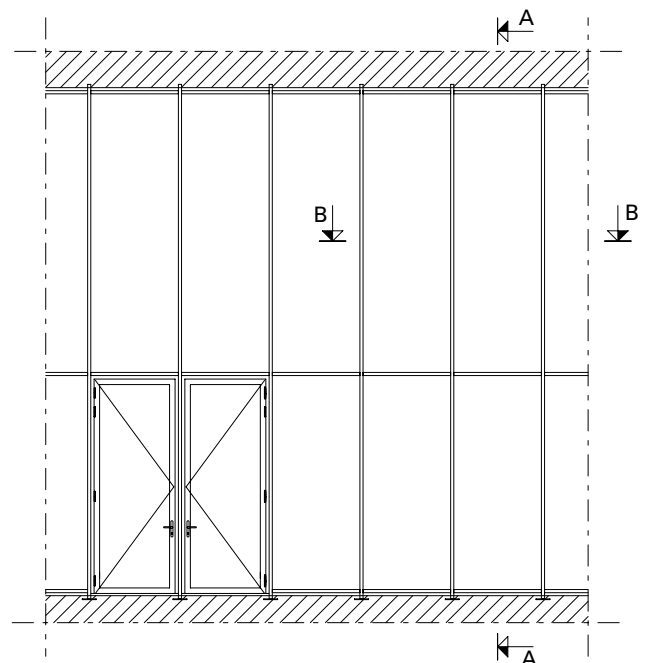
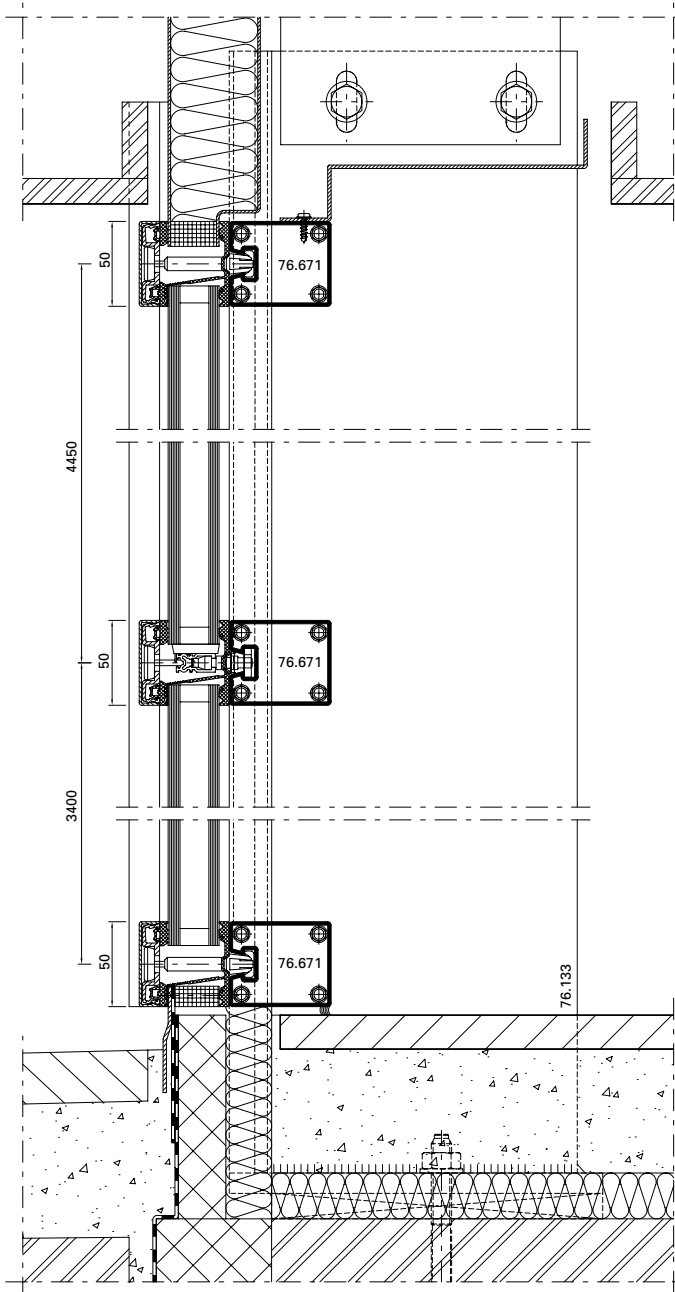

Ausgeführte Objekte Objets réalisés Completed projects

Objekt:

Werkhalle Glas Trösch,
St.Gallen/CH

System:

VISS TVS

Architekt:

Schuchter Ehle, Architekten, St.Gallen/
CH

Objet:

Atelier de Glas Trösch,
Saint-Gall/CH

Système:

VISS TVS

Architecte:

Schuchter Ehle, Architekten,
Saint-Gall/CH

Project:

Glas Trösch factory building,
St. Gallen/CH

System:

VISS TVS

Architect:

Schuchter Ehle, Architekten, St.Gallen/
CH





Objekt:

Voentorg Center,
Moskau/RU

System:

VISS TV, VISS Fire

Architekt:

Mosprojekt-2: Kolosnitsin Vladimir
Vasilyevich / Starikov Alexander
Fedorovich, Moskau/RU

Objet:

Centre Voentorg,
Moscou/RU

Système:

VISS TV, VISS Fire

Architecte:

Mosprojekt-2: Kolosnitsin Vladimir
Vasilyevich / Starikov Alexander
Fedorovich, Moscou/RU

Project:

Voentorg Center,
Moscow/RU

System:

VISS TV, VISS Fire

Architect:

Mosprojekt-2: Kolosnitsin Vladimir
Vasilyevich / Starikov Alexander
Fedorovich, Moscow/RU



Ausgeführte Objekte Objets réalisés Completed projects

Objekt:

Neue Messehalle
(Kielce Trade Fairs), Kielce/PL

System:

VISS TVS (vertikal und schräg),
Janisol 2 E130, Falttore

Architekt:

bsp Architekten: Barbara Średniawa,
Gliwice/PL

Objet:

Nouveau hall d'exposition
(Kielce Trade Fairs), Kielce/PL

Système:

VISS TVS (vertical et oblique),
Janisol 2 E130, Porte accordéon

Architecte:

bsp Architekten: Barbara Średniawa,
Gliwice/PL

Project:

New exhibition hall
(Kielce Trade Fairs), Kielce/PL

System:

VISS TVS (vertical and sloping),
Janisol 2 E130, Folding doors

Architect:

bsp Architekten: Barbara Średniawa,
Gliwice/PL



